

BROADCAST NEWS

NOW THERE ARE 3 RCA
LIVE COLOR CAMERAS



Vol. No. 133
APRIL 1967

NEWEST AND FINEST TV RECORDER

FOR COLOR TAPES...TR-70—newest high band color recorder. Does everything, has everything (good) that the very best previously available recorder could boast of. In addition, it offers a whole host of new features. A "matched" equipment from RCA.

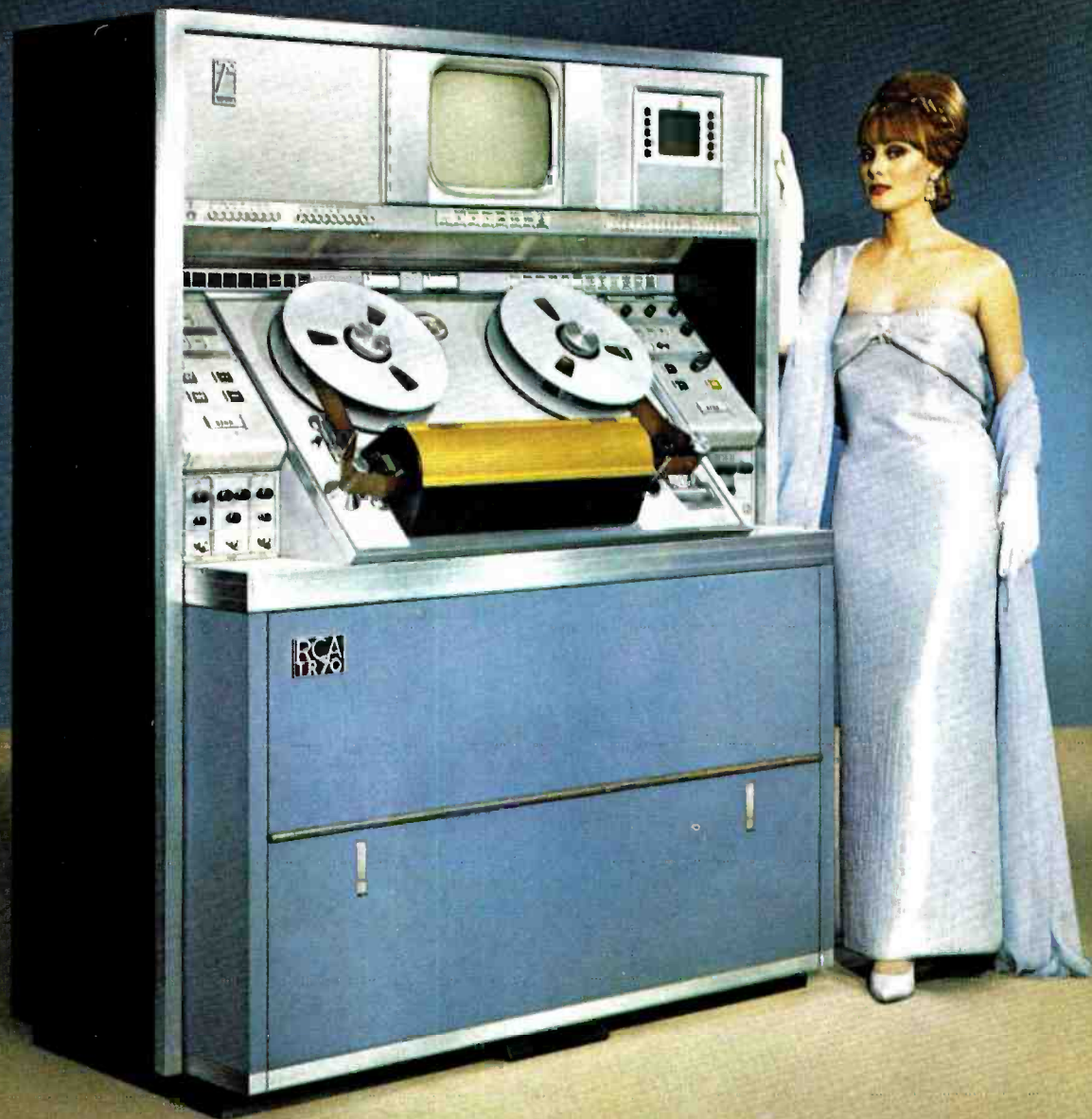

The Most Trusted Name In Electronics

Vol. No. 133

April, 1967

BROADCAST NEWS

published by

RADIO CORPORATION OF AMERICA
BROADCAST & COMMUNICATIONS PRODUCTS DIVISION, CAMDEN, N. J.

issued bi-monthly

PRICE *in U.S.A. - - - - - \$6.00 for 6 issues*
outside U.S.A. - - - \$7.00 for 6 issues

C O N T E N T S

	Page No.
Maintaining Modern TV Transmitter Performance	8
KHQ-TV Updates Color Facilities	25
Four-Tube Separate Luminance Color TV Camera	30
WCEE-TV Success in UHF	48
WABC-TV Installs "Zee Panel" Antenna	54
New "Big Tube" Color Camera for Field Pickups	61

Copyright 1967 Radio Corporation of America All Rights Reserved Trademark(s) Registered. Marca(s) Registrada(s)

PRINTED
IN
U.S.A.

Now...there are



THE TK-42 DELUXE STUDIO CAMERA (with internal zoom) —the finest color camera ever offered—with more built-in operating and convenience features than any other. Big $4\frac{1}{2}$ -inch-diameter luminance channel tube (nearly 4 times larger than in other cameras) insures best detail, sharpest pictures. I.O. characteristic (the "knee") handles wider contrast range—provides most brilliant, most exciting pictures. New Type 4536 Tube gives longer life, eliminates burn-in problems. With new field-effect transistorized preamplifiers and other circuit improvements, provides a dramatic reduction in noise level. Available in 1968—adaptor kits for use of lead-oxide tubes in chrominance channels.

THE TK-43 DELUXE STUDIO CAMERA (with external zoom) offers all the fine features of the TK-42 with the flexibility of a 10-to-1 lens system. Permits the use of range extenders to triple focal length—from 1.6 inches to 4.8 inches, or from 16 inches to 48 inches. Can also be used with standard fixed focal length lens. Makes one of the most versatile color cameras available. The 1967 models of the TK-42 and TK-43 incorporate many new developments providing improved color tracking, reduced noise level and lower operating cost—part of RCA's continuing product improvement program. Available in 1968—adaptor kits for use of lead-oxide tubes in chrominance channels.

3 RCA "Big tube" live color cameras...

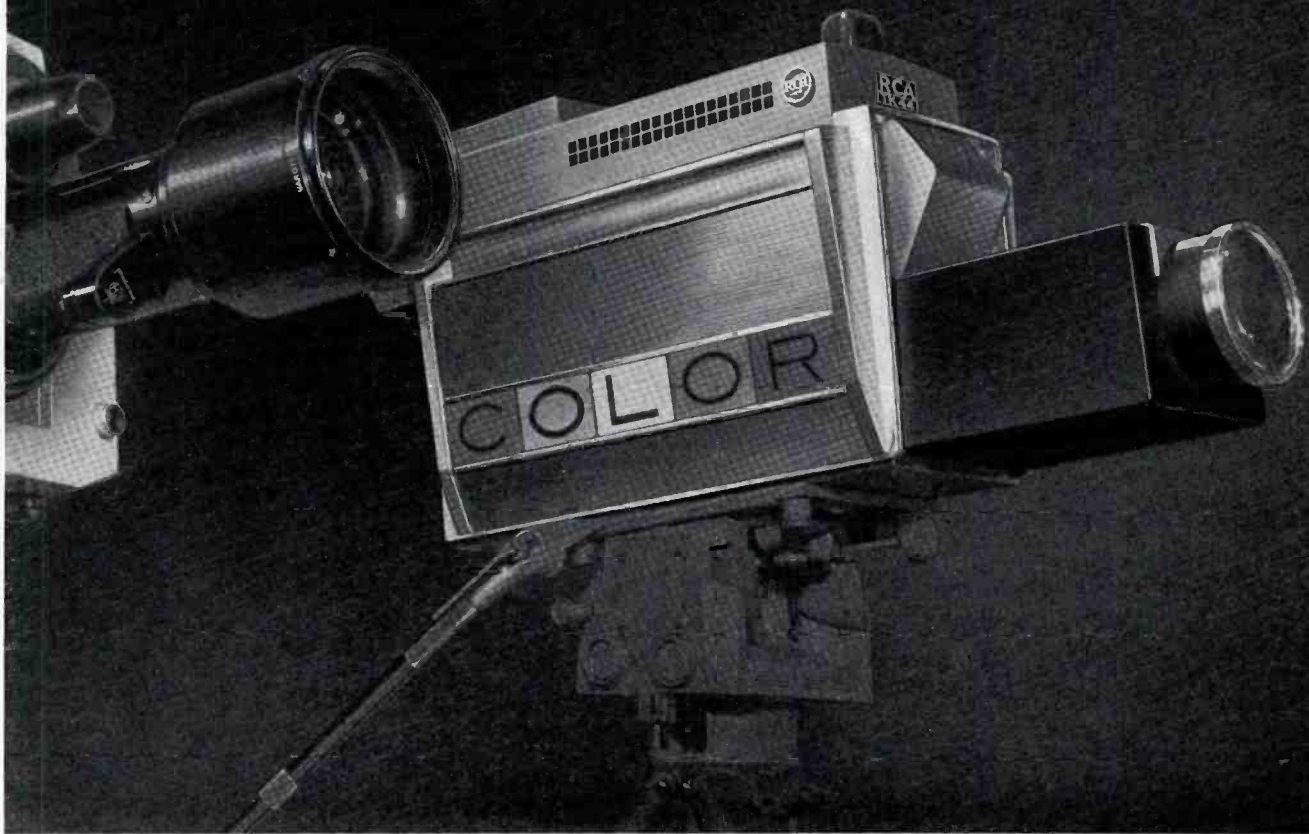

THE NEW TK-44 "ISOCON" CAMERA, an entirely new light-weight color camera for those who want the advantage of "big tube" detail and image orthicon performance in a smaller-size unit. Weighs only 140 pounds (exclusive of detachable viewfinder and lens). Ideal for remote pickups and other field applications as well as studio use. The revolutionary new RCA 3-inch Isocon tube in the luminance channel combines inherently low-noise characteristic with the recognized advantage of the I.O. characteristic (the "knee") in handling a wide contrast range. Chrominance channels in production models will employ three lead-oxide tubes. The best of both worlds!

Call your RCA Broadcast Representative. Or write RCA Broadcast and Television Equipment, Bldg. 15-5, Camden, N.J. 08102.



THE MOST TRUSTED NAME IN ELECTRONICS



New transmitter

Up to 5 megawatts
ERP tailored to indi-
vidual requirements.

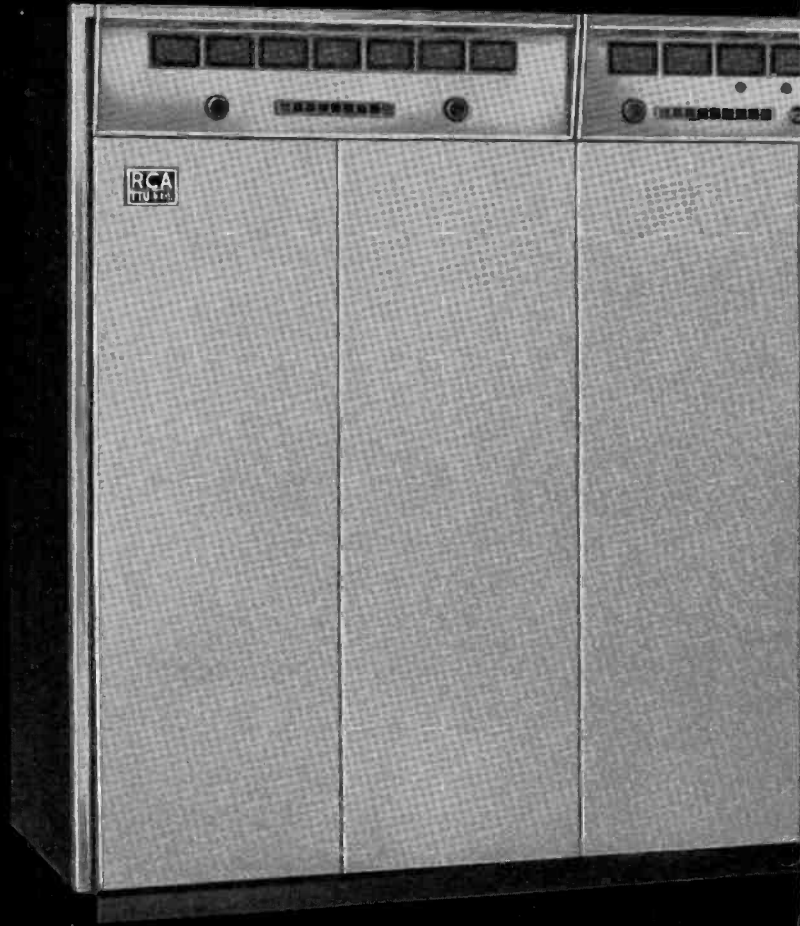

Diplexed Power Amplifiers...

Our newest UHF transmitter, combined with the right RCA antenna, provides RCA's most powerful transmitter-antenna package, affording up to 5 million watts ERP.

RELIABLE OPERATION The diplexed visual power amplifiers assure the utmost in reliability. One amplifier is always ready to back up the other.

NEW TYPE KLYSTRONS Unique, integral-cavity vapor cooled klystrons are a high power development of those used in the proven RCA TTU-30A and TTU-50C Transmitters. Reliability and long life are major advantages, with faster warm-up time, less weight and pretuning among other points of superiority.

VAPOR COOLING EFFICIENCY Vapor cooling is much more efficient than water cooling. This results in reduced operating expense. Lower input power is required.

for high power UHF

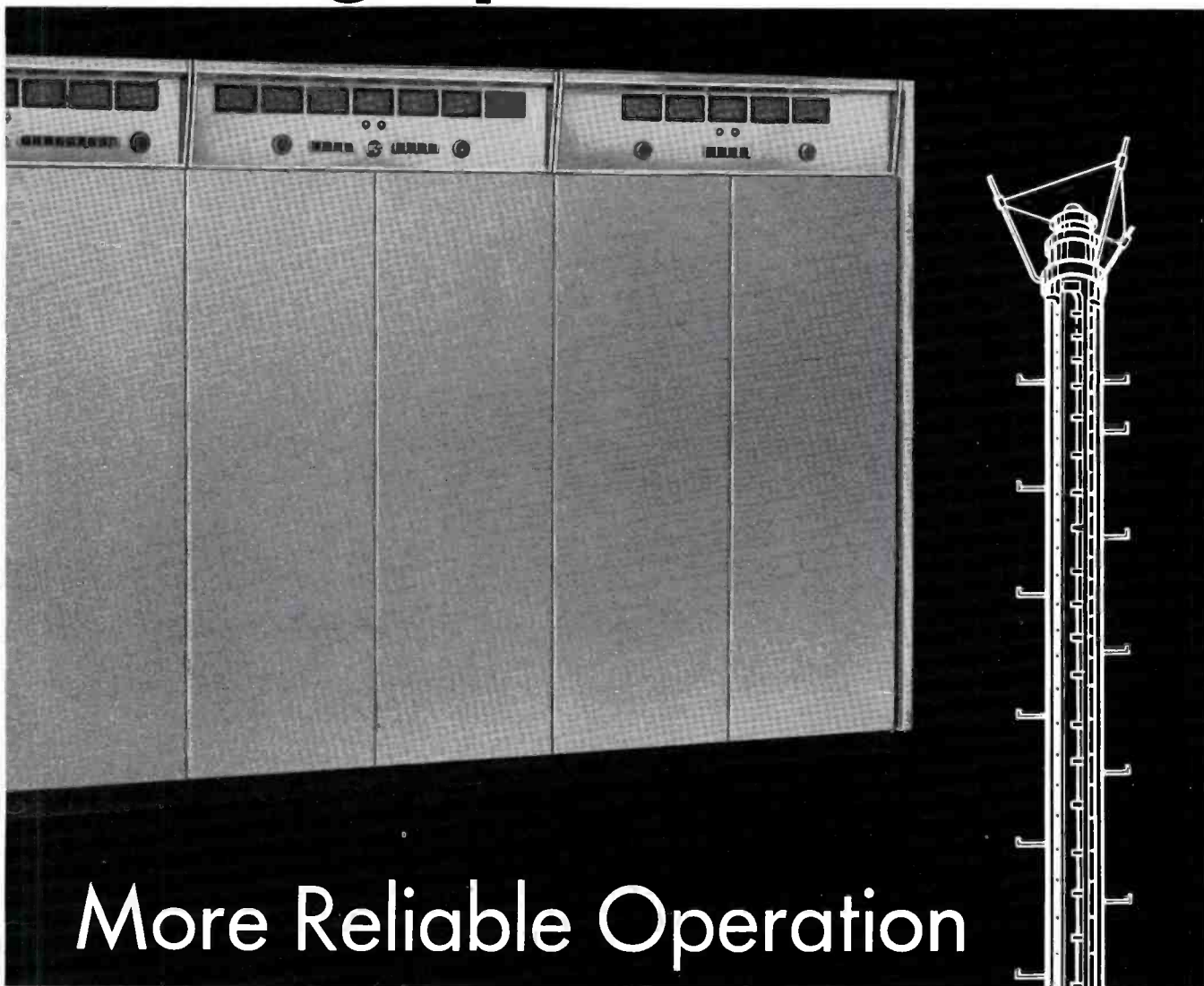

More Reliable Operation

WALK-IN DESIGN New design techniques and walk-in cabinetry result in smaller size and easy maintenance. This means direct savings in installation and operation and will minimize building expense.

ANTENNA CHOICES Only RCA offers a choice of Pylon, Zee-Panel, and Vee-Zee Panel Antennas for use with the new TTU-110A high power UHF Transmitter.

OTHER UHF TRANSMITTERS Also in this UHF line are the 30KW RCA TTU-30A and 55KW TTU-50C with integral cavity vapor cooled klystrons. Also a completely air cooled 10KW TTU-10A and a 2KW TTU-2A (easily expanded to a TTU-10A).

For more information, call your RCA Broadcast Representative. Or write RCA Broadcast and Television Equipment, Building 15-5, Camden, N. J. 08102.

YOU GET SO MUCH MORE FROM RCA

RCA offers the only full-line of broadcast equipment. RCA's depth and breadth of engineering skills and improved products, ensuring better performance, are your assurance of greater value. From RCA you get matched system design, overall warranty responsibility, single supplier coordination and complete engineering service.



THE MOST TRUSTED NAME IN ELECTRONICS



Donna Rae Wood smiles engagingly as she cradles No. 4536 like the newborn 4½-inch image orthicon that it is. New pickup tube that reduces signal-to-noise ratio made its debut in TK-42/43 cameras.

1967 NAB EXHIBIT SETS NEW RECORDS IN COLOR TV EQUIPMENT INTEREST, SALES

As the last picture monitor blinked out and the equipment "explainers" sank wearily into the nearest chairs, the results of RCA's big exhibit at the 1967 NAB convention could be toted up. They spelled N-E-W R-E-C-O-R-D by any measure: in new business signed at the show and scheduled for the ensuing 60-90 day period, in total exhibit traffic, in the excited interest expressed in the new TK-44 and the improved TK-42/43 color cameras.

It was clear that the color TV whirlwind, which had slowed almost to a zephyr in pre-convention months, was blowing hard again. The annual NAB comparison shopping was over, the economy was looking stronger, competitive pressures were more evident, and broadcasters were flashing the "buy" sign.

In color equipment, as the trade press noted, the 1967 NAB was a year of perfection. Not just color, but better color from advanced equipment, was the keynote. In cameras and tape particularly,

RCA showed what it meant to be leader in the design and development of color broadcast equipment.

In its debut, the new TK-44 color field camera demonstrated how light carrying weight (140 pounds, exclusive of detachable viewfinder and lens) can be combined with the ability to handle high contrasts in lighting encountered in outdoor pickups.

The camera faithfully reproduced the multi-colored scene as the afternoon shadows, induced by special lighting, fell over a model football stadium on the set.

For luminance, the TK-44 introduced a new 3-inch pickup tube, called the Isocon, which evidenced significant improvement in signal-to-noise and showed as well the exposure latitude, resolution and sensitivity characteristic of the image orthicon.

The studio proven TK-42/43 cameras—nearly 400 are in service—were equipped with a newly-developed 4½-inch image orthicon for the NAB demonstration. The

(Continued on next page)

In this unposed study of earnest conversation, RCA exhibit visitors hear the TTU-110A story and how the new UHF transmitter will develop up to 5 megawatts ERP.





New TK-44 color camera eyes coeds in the dorm as demonstration gets under way before NAB visitors.

new tube, which is being made available for cameras now in use, also achieves a better signal-to-noise ratio, the result of close target-to-mesh spacing. In addition, new target material helps maintain good sensitivity in the tube throughout its life.

On the tape side, the TR-70 high-band color system reproduced pictures that brought to color TV the same "indistinguishable from live" quality that startled viewers of the first black-and-white taped shows a few years back. It can be truly said that color tapes made with the TR-70 approach photographic quality.

A third bright star in the RCA firmament was the new 110-KW UHF television transmitter, a sleek, sensibly-cabineted beauty that, when combined with an RCA ultragrain antenna, will radiate up to five megawatts ERP on channels 14 through 50. For UHF-ers planning higher powers, it proved to be a major NAB attraction.

There was much more to be seen around the 8,200 square foot exhibit in the Conrad Hilton Hotel, and Broadcast News will give you a more complete report in its next issue. The record-breaking 1967 NAB is finished, the big whirlwind of color TV is blowing hard again.



In the RCA exhibit area, KRTV representatives group around the TK-27 color film system purchased during NAB convention. From left, Jesse Waymire, Chief Engineer; Dan Snyder, President, and Ray Harding, RCA broadcast sales. The Great Falls station purchase makes Montana an all-RCA state for broadcasters using studio equipment to originate color film and slide programs.

Visiting RCA's Camden facilities, P. K. Macker (left), President of Inter-Island Broadcasting, Manila, is shown TK-42 color camera by G. D. Buchanan, RCA international sales, and Charles H. Colledge, RCA Division Vice President and General Manager. The Channel 13 station recently acquired a new 12.5 KW transmitter and color film system and is planning a future move into live color.



FIG. 1. Adjusting the 50 kW TTU-50C UHF transmitter for proper differential phase and gain characteristics.

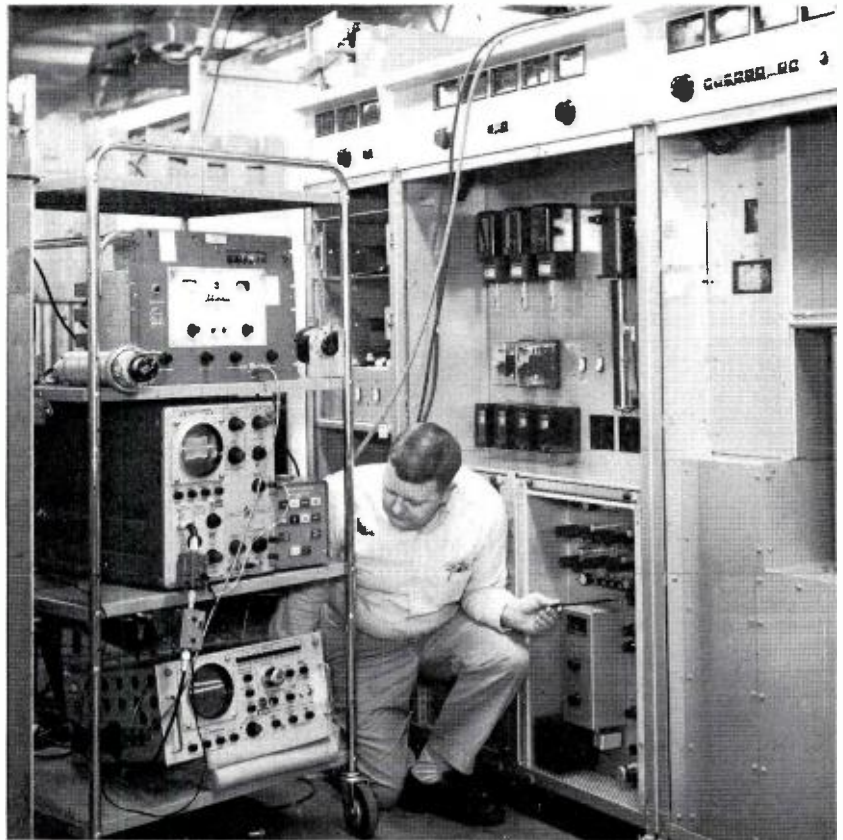

MAINTAINING MODERN TV TRANSMITTER PERFORMANCE

Getting Maximum Efficiency and Bandwidth for the Best Color and Monochrome Picture Quality

by D. W. SARGENT, *Product Specialist*
Broadcast Transmitter Merchandising

When television broadcasting was in monochrome only, frequency response was about all most stations tested on a routine basis, with an occasional check on linearity by those possessing a linearity generator. With the conversion to color much more measuring and adjusting is required for proper bandwidth and top performance. Yet, most stations are doing little to check such things as differential phase, differential gain, variation of output (over one frame), precise power output, and other important characteristics of their transmitting system.

Some station operators have this done once a year on a contract basis by RCA Service Company; others, at installation only. With the vast increase in color, both network and local, emphasis is mounting on getting and keeping optimum performance so that reception in home TV receivers stays at a high level.

One fact stands out as the state of the art progresses, more attention to obtaining and maintaining specifications within close tolerances will be required if citations are to be avoided.

This article is intended to assist station personnel who wish to perform their own transmitter tests and adjustments for proper bandwidth, good tube life and maximum performance. The article covers both the visual and aural parts of the transmitter.

Proper Test Equipment

With the necessary auxiliary equipment installed (such as input equalizers), the modern television transmitter is capable of meeting all existing specifications, but only

WHAT THIS ARTICLE COVERS

TRANSMITTER CHARACTERISTICS	TEST PROCEDURES	TEST EQUIPMENT USED
Visual	Visual	
Amplitude vs. Frequency Response	Input Equalizer Response	Thru-Line Power Meters
Variation of Frequency Response with Brightness Level	Unmodulated Exciter Tuning	Sideband Response Analyzer
Variation of Output Over One Frame	Modulated Amplifier Tuning	Demodulator
Regulation of Output	Modulated Exciter Tuning	Electronic Chopper (installed in Demod.)
Power Output	Overall Frequency Response of VHF Transmitters	Vectorscope
Linearity	UHF Transmitter Tuning	Oscilloscope or Waveform Monitor
Differential Gain	Diplexed Amplifier Transmitter Tuning	Stairstep Generator (with Modulation)
Differential Phase	Parallel Transmitter Amplifier Tuning	Sine Squared Pulse and Window Generator
Envelope Delay	Variation of Output with Brightness	Envelope Delay Test Set
	Differential Gain and Phase	
	Envelope Delay Test	
Aural	Audio	
Frequency Response	Aural Frequency Response	Cross-Over Filter (for Differential Gain Check)
FM Noise	Distortion	Audio Oscillator
AM Noise	FM Noise of Aural Transmitter	Distortion Analyzer
	AM Noise of Aural Transmitter	

when the proper test equipment is used to set it up. A list of test equipment used in the procedures described in this article is shown in the Table.

Some waveform monitors do not use a "keyed clamp" and present an unusable display when a relay type chopper is used. An electronic vertical interval type chopper is preferable because it works with all scopes and waveform monitors, and has the advantage of operating continuously, giving a constant check on depth of modulation for test and operating purposes. An RCA MI-43993-B chopper installed in the demodulator meets all these requirements. The demodulator should be designed for color. It is important that all test equipment be up to specifications, because any errors in this equipment will be compensated for in the transmitting system and will provide an improper signal to the receivers.

For the purpose of this article it is assumed that the necessary switching and/or disabling of aural or visual circuits has been accomplished and will not be covered.

The exciter is defined as that unit which contains the oscillator and multiplier stages at low level power. The basic transmitter

refers to stages of amplification or multiplication that are physically separated from the exciter and are usually higher power stages.

Input Equalizer Response Test

Before tuning of the transmitter proper, the equalizing equipment should be checked for a flat response with a sweep (TV Sideband Response Analyzer, BW-5C/BWU-5C). Equalizers are used to correct envelope delay (discussed later) and should not affect frequency response, i.e.; video sweep should be flat at the low-pass filter output. It is necessary to use amplitude equalizers in the "equalizer string" to achieve this flat condition to compensate for roll-off of the equalizers. Figure 2 is the recommended line up of equalizers and their distribution amplifiers, used to properly terminate the equalizers and compensate for gain reduction of the equalizers. If stretch is used in a Stab Amp, it should be after the phase equalizers.

If the response shows a rise in high frequency response, remove one of the amplitude equalizers. The notch equalizer is used when the system employs a notch diplexer. If some other system is used the

notch equalizer is not used. Consult the instruction book for the proper line up for your particular equipment.

If a Stab Amp is used, it should be checked with the sweep at the same time as the equalizers, making sure to consult the instruction book of the Stab Amp used because some circuits must be disabled for sweeping.

If any deficiencies show up in the equalizer string, perform a step by step check starting at the Stab Amp, if used, to determine the fault. When all the input equipment is operating properly connect it to the transmitter video input in preparation for transmitter tuning.

Exciter Tuning (RF) Units With No Video Modulation

Consult the Instruction Book for your particular transmitter for the procedure to obtain proper meter indications to insure maximum efficiency and tube life.

One recommendation applicable to all transmitters is to install a thru-line watt meter, (such as Bird Electronics Model 43) using the appropriate element for the power and frequency of the exciter output, fed

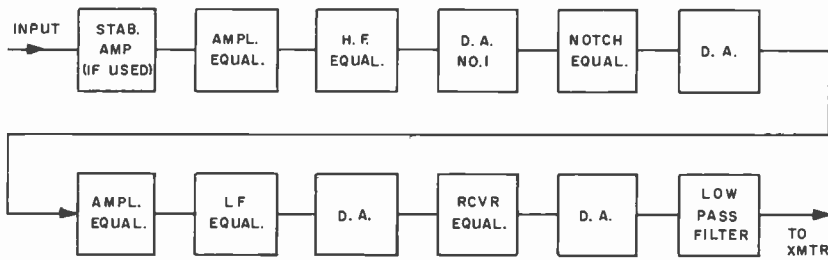

FIG. 2. Block diagram showing proper lineup of equalizers and distribution amplifiers. If stretch is used in the Stab Amp, the unit should be placed after the phase equalizers rather than as shown.

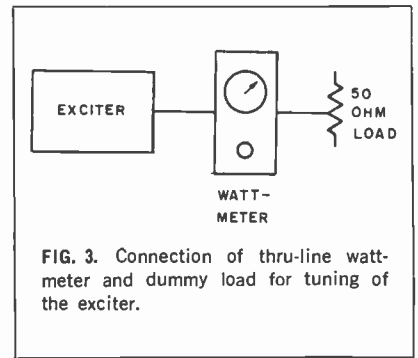

FIG. 3. Connection of thru-line wattmeter and dummy load for tuning of the exciter.

into a dummy load instead of the first stage of the basic transmitter. See Fig. 3.

When the tuning of the exciter is completed the power output can be noted on the watt meter to insure it being at the proper value.

Turn the power off leaving the watt meter in the output line. Remove the dummy load and reconnect to the first stage of the transmitter input. Rotate the element in the watt meter to the "Reflected" position. Turn the power on to the basic transmitter and tune the input for minimum reflected power as indicated on the watt meter. This point should also indicate maximum grid current of the next stage. Remove the wattmeter from the circuit when the exciter tuning is completed.

Tuning Modulated Amplifier (VHF and Older UHF)

In all but the new UHF transmitters, video modulation takes place at "high level." In some cases, this will be the output stage of the transmitter and in others it will be a driver for higher power amplifiers. In either case the transmitter is set up as shown in Fig. 4.

Disconnect the driver from the rest of the transmitter and terminate it into the dummy load and thru-line wattmeter.

Tune the amplifiers and/or multiplier stages following the exciter up to the modulated amplifier for maximum output of each stage, or maximum drive to next stage. Check your instruction book for proper meter indications to insure proper operation, keeping in mind that instruction book meter indications are typical and may not necessarily be exact.

Tuning of the modulated amplifier requires the use of the sideband response analyzer. The modulator is set-up as follows:

AC Coupled—Mid Characteristic*
Linearity Corrector Off
(If in Modulator)

20 Percent Peak to Peak Modulation

Low Pass Filter Switched Out

Sideband Response Analyzer Set-Up as Shown in Fig. 5

Note—Directional Coupler must be properly set-up with good co-ax cables and properly installed connectors of the correct

* Mid characteristic = peak power $\times 0.56 \times 0.45$, or, 0.45 of the voltage corresponding to synchronizing peak. The 0.56 factor is necessary to convert peak power to CW power because of the average-reading watt meter.

type used with the video and RF to the sideband response analyzer. Do not overload response analyzer.

If the modulated amplifier is the final stage of the transmitter, tune it for 4.2 MHz bandwidth. If it is to be used as a driver for higher powered amplifiers tune it for a wider bandwidth, about 4.5 MHz to 4.75 MHz.

The lower sideband should be about 0.5 MHz. Tune for the bandwidth listed above (4.2 MHz or 4.5 to 4.75 MHz depending on usage) consistent with maximum power output as shown on the thru-line wattmeter. If the wider bandwidth will not

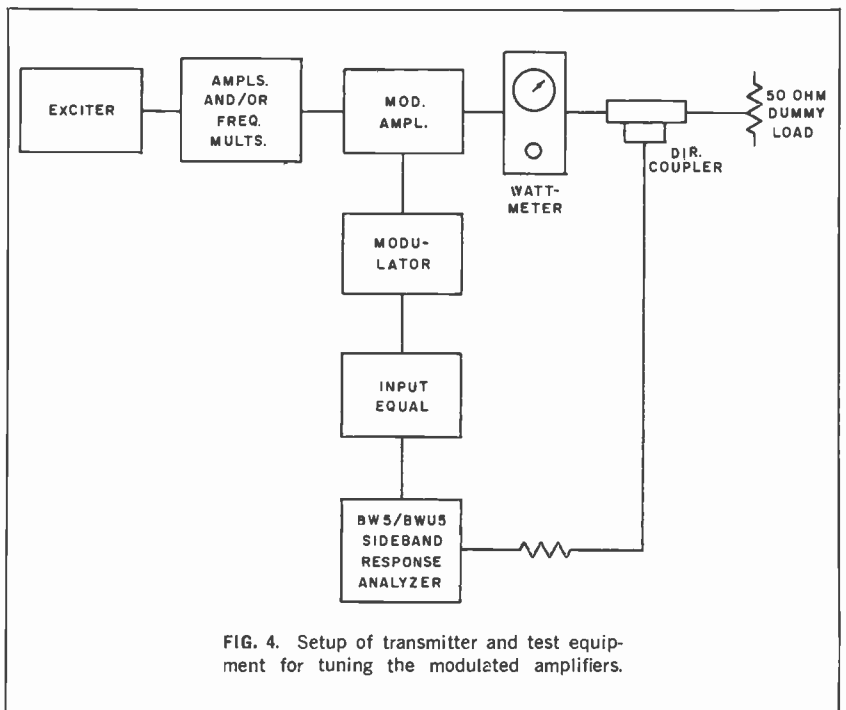
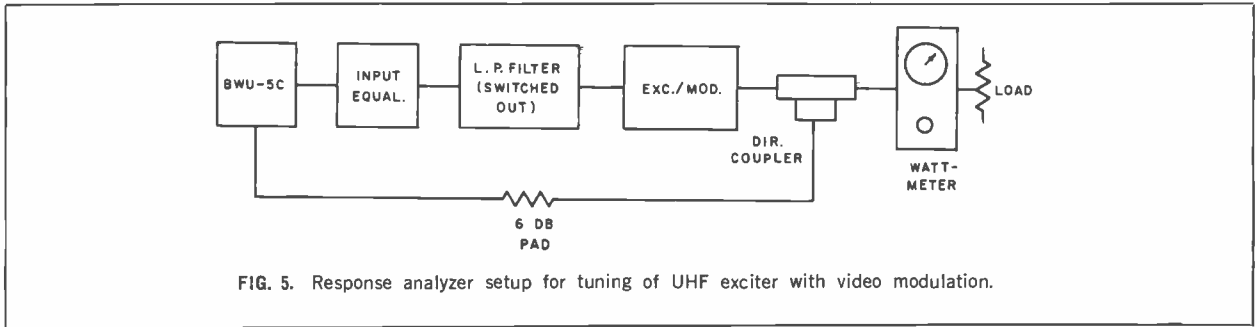

FIG. 4. Setup of transmitter and test equipment for tuning the modulated amplifiers.



give full power output, this can be corrected later by reducing the bandwidth. At this time the wider bandwidth is necessary for later amplifier tuning.

When tuning for 4.2 MHz bandwidth, full power should be possible without difficulty. Insufficient lower sideband response will adversely effect the envelope delay procedure described later.

Meter indications must be observed during tuning operations to avoid damage to the tube amplifier.

Once this tuning procedure, into the dummy load, is complete, DO NOT TOUCH THE TUNING CONTROLS ANY MORE.



FIG. 6. VHF directional coupler for use with 1/8-inch transmission line. Available from Microwave Devices are Models 361.9 for low band VHF and 361.12 for high band VHF.



FIG. 7. UHF directional coupler for use with flexible coaxial line.

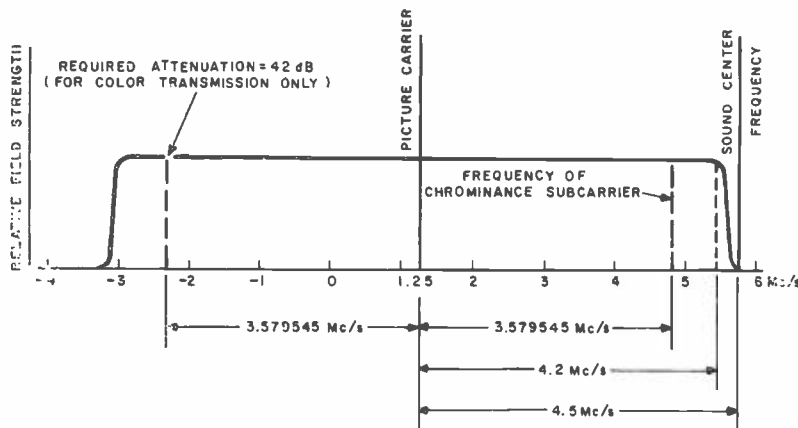

FIG. 8. Idealized double sideband picture transmission amplitude characteristic.

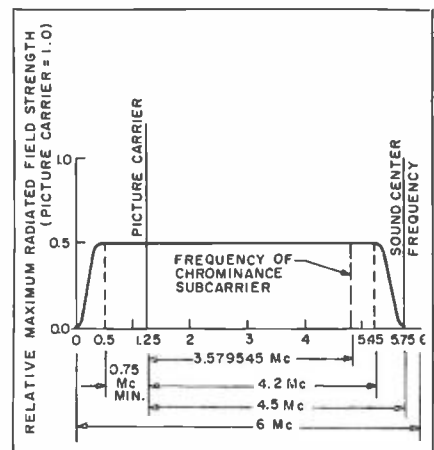

FIG. 9. Idealized vestigial sideband picture transmission amplitude characteristic.

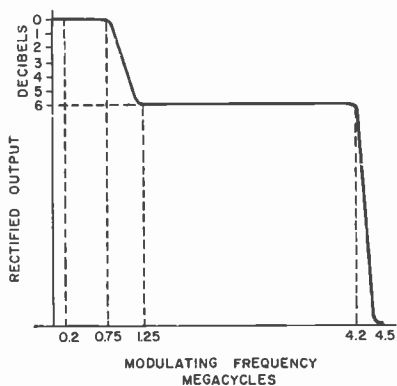

FIG. 10. Ideal detector output as displayed by diode detector.

Exciter Tuning (RF) Units With Video Modulation (UHF)

The latest generation UHF transmitters use an exciter/modulator. The last RF stage of this exciter is modulated with video therefore it must be tuned for both RF output and proper bandwidth.

Install a thru-line wattmeter and dummy load suitable for the power and frequency range as shown in Fig. 4. A 5-watt dummy load or RF attenuator is sufficient at this point. The wattmeter element can be 2.5 Watts, 400-1000 MHz. Tune each RF stage to obtain the meter indications outlined in your instruction book for proper operation. Do not exceed 30 on the plate current meter for V108 and V109 or the tube will be damaged or at least its life will be shortened.

Tuning of V109 must be done using a sideband response analyzer because this stage is the modulated stage as well as the exciter output mixer. See Fig. 4 for setup. Modulator configuration is as follows:

- AC Coupled—Mid Characteristic
- Linearity Corrector Off
- 20 Percent Peak to Peak Modulation
- Low Pass Filter Switched Out
- Sideband Response Analyzer setup as in Fig. 4

Adjust the double cavity tuning controls, coupling between cavities and output coupling, for a flat response of 4.5 MHz upper sideband and sufficient lower sideband (about 0.5 MHz) consistent with maximum power output as indicated on the wattmeter. (The bandwidth will be narrowed later to increase power to 2.5 Watt peak with 4.2 MHz bandwidth.)

Remove load from output of exciter/modulator and connect to the first stage of

the basic transmitter. Recheck and correct output sweep response at input to driver.

Note: It is important that the co-ax cable used for video feed and RF feed to the sideband response analyzer be in good condition and all connectors be properly installed and of the right type because discontinuities here can affect response. Use only directional couplers, properly set, or attenuators of proper value to feed the response analyzer with a 6 dB pad in the input of the analyzer.

Overall Frequency Response of VHF Transmitters (other than Diplexed and Parallel)

The various model transmitters have both different tube types following the modulated amplifier as well as different numbers of amplifiers. Some models have only one amplifier and others have two following the modulated amplifier; regardless of the number, the procedure for each is the same, requiring only a duplication if more than one is used. It is important to take them one at a time however, because if more than one is tuned at a time, one may compensate for the other. Figure 11 illustrates the sequence for those transmitters using two amplifiers following the modulated amplifier, while Fig. 12 is used for transmitters using only one additional amplifier.

Using the set-up shown in Fig. 11, the first amplifier (in transmitters using two) input tuning controls are used to get minimum reflected power back into the modulated amplifier consistent with a flat

response. As shown at directional coupler A (amplifier input) the VSWR should be 1.1 to 1.2 and response the same as the modulated amplifier into the dummy load. After these two conditions have been satisfied, the output of the amplifier can be tuned. No tuning of the modulated amplifier controls should be used to get input response.

Connect the sideband analyzer to directional coupler B and tune for power output and response. If the amplifier is the final amplifier broadband it for 4.2 MHz. If another amplifier is to follow it, broadbanding should be slightly less than the modulated amplifier, but more than 4.2 MHz.

When switching between the directional couplers A and B it should show less bandwidth on B. This will insure that the modulated amplifier is not limiting the width of the sweep. This might result in the amplifier following being wider and not making power.

If another amplifier follows the preceding amplifier, the procedure is the same. Broadband this amplifier for 4.2 MHz. Input tuning is the same as for the first amplifier.

Once an amplifier has been tuned (broadbanded) into a dummy load do not use the tuning controls again. If it is impossible to bring the response at the input of an amplifier to proper shape and/or VSWR to 1.2 maximum, shorten or lengthen the line connecting the driver stage and the amplifier input until this condition can be met.

By making the modulated amplifier frequency response 4.5 to 4.75 MHz wide in

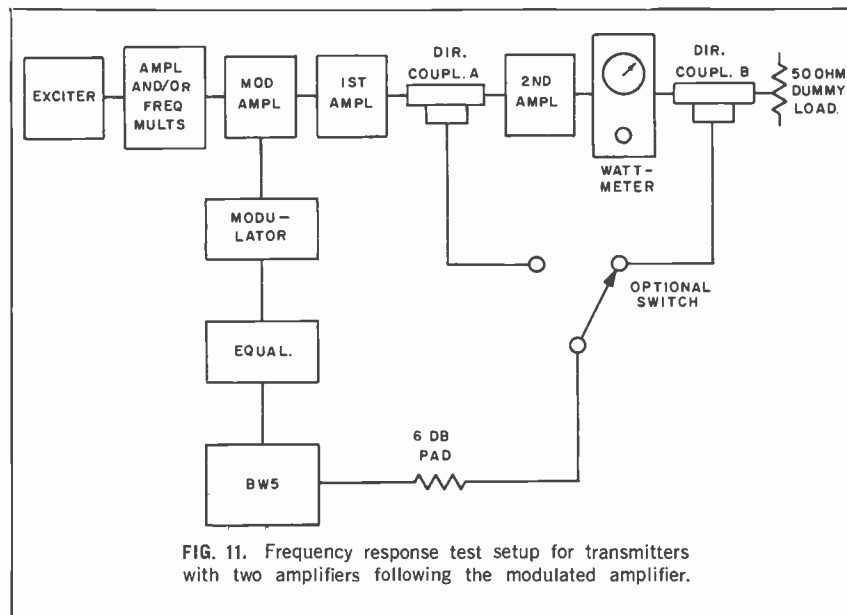

FIG. 11. Frequency response test setup for transmitters with two amplifiers following the modulated amplifier.

order to insure that the amplifier following is narrow enough, the amount of drive from this stage will be lower than specifications. If more drive is required, it will be necessary to go back and connect the modulated amplifier back into the dummy load and tune it for 4.2 MHz response, hence more power.

It is possible to tune each stage of the transmitter at 4.2 MHz bandwidth initially, however, until complete familiarity with the transmitter tuning and how each control affects the response and power, the method outlined is recommended.

In low band VHF transmitters, the output power of the amplifiers may be down unless the response is "rolled off" slightly. The maximum roll-off should not exceed 3 dB. To compensate for this the driver is "peaked-up" by the same amount so the over-all response is flat.

If this is done, keep the response flat (sloped or tilted) whether up or down, and not "humped" or with "hills and valleys."

Tuning UHF Transmitters

If the transmitter being tuned is one of the tube-type UHF models (TTU-12A/25B, 2A 10A types, the output tuning is quite different from the foregoing and is done as follows:

Using probes (Fig. 13), UHF signal generator, RF voltmeter and frequency meter, adjust the cavity bandwidth as described in your transmitter instruction book. In the older UHF transmitters the cavity bandwidth is quite wide, however, these are 3 dB points and we are looking for a flat response of the output, so that slight retuning of the plate tuning control is required to get response at the high end when using sweep. No tuning is done with the **LOADING** or **BANDWIDTH** controls once the bandwidth is set using probes. When the bandwidth of the cavities is set, proceed with sweeping and checking of the transmitter as described under Overall Frequency Test.

Connect the exciter to the next stage of the transmitter, leaving the directional coupler installed in the output of the exciter temporarily (or permanently if desired). The stages following the exciter/modulator have no input tuning and matching controls, so that it is necessary to slightly retune the exciter output circuits for response if it has changed. The directional coupler can now be removed from the exciter output line if desired.

If the transmitter is a TTU-30A or similar, the stage following the exciter is a

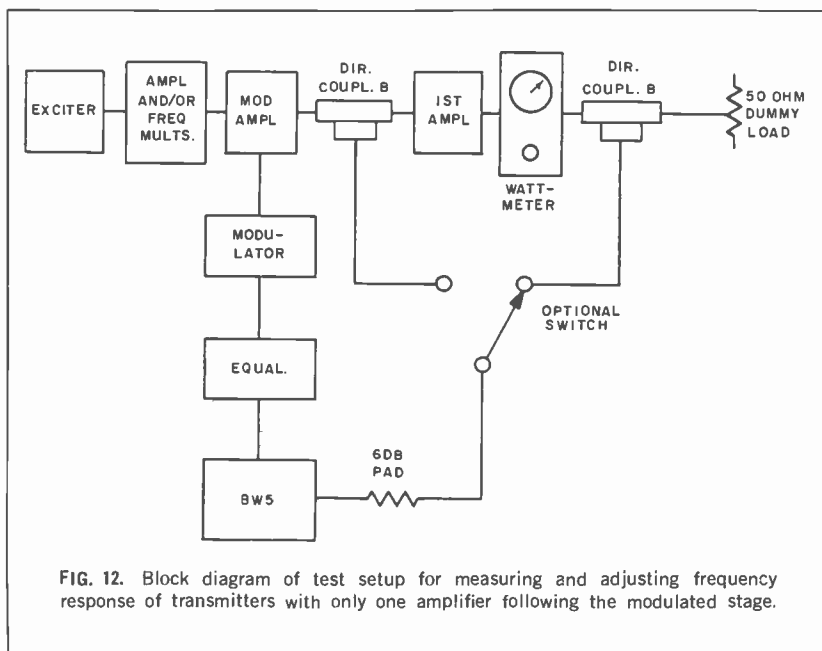

FIG. 12. Block diagram of test setup for measuring and adjusting frequency response of transmitters with only one amplifier following the modulated stage.

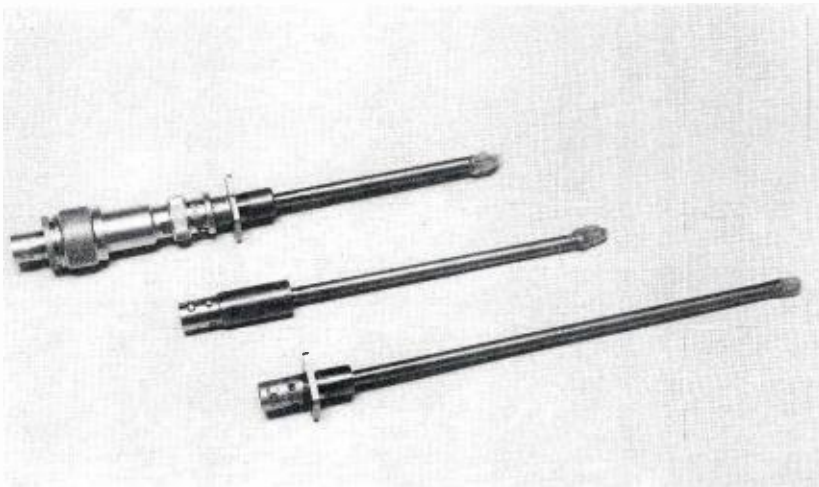

FIG. 13. UHF probes used with UHF signal generator, RF voltmeter and frequency meter to adjust UHF transmitter cavity bandwidth.

cavity and has input tuning and is done as follows:

In place of the load on the thru-line wattmeter, substitute the next stage. With the thru-line wattmeter adjusted to indicate reflected power, adjust the input of the cavity for minimum reflected power, consistent with good response.

Couple a load of appropriate size through a thru-line wattmeter and directional cou-

pler to the output of the stage following the exciter, and tune this stage. Proceed through the entire transmitter as outlined in Overall Frequency Response Test. As some of the amplifiers may drop off in response up to 3 dB (depending on type, etc.) it may be necessary to "peak" the response of the exciter modulator to achieve flat response. This allows the amplifiers to operate at maximum efficiency.

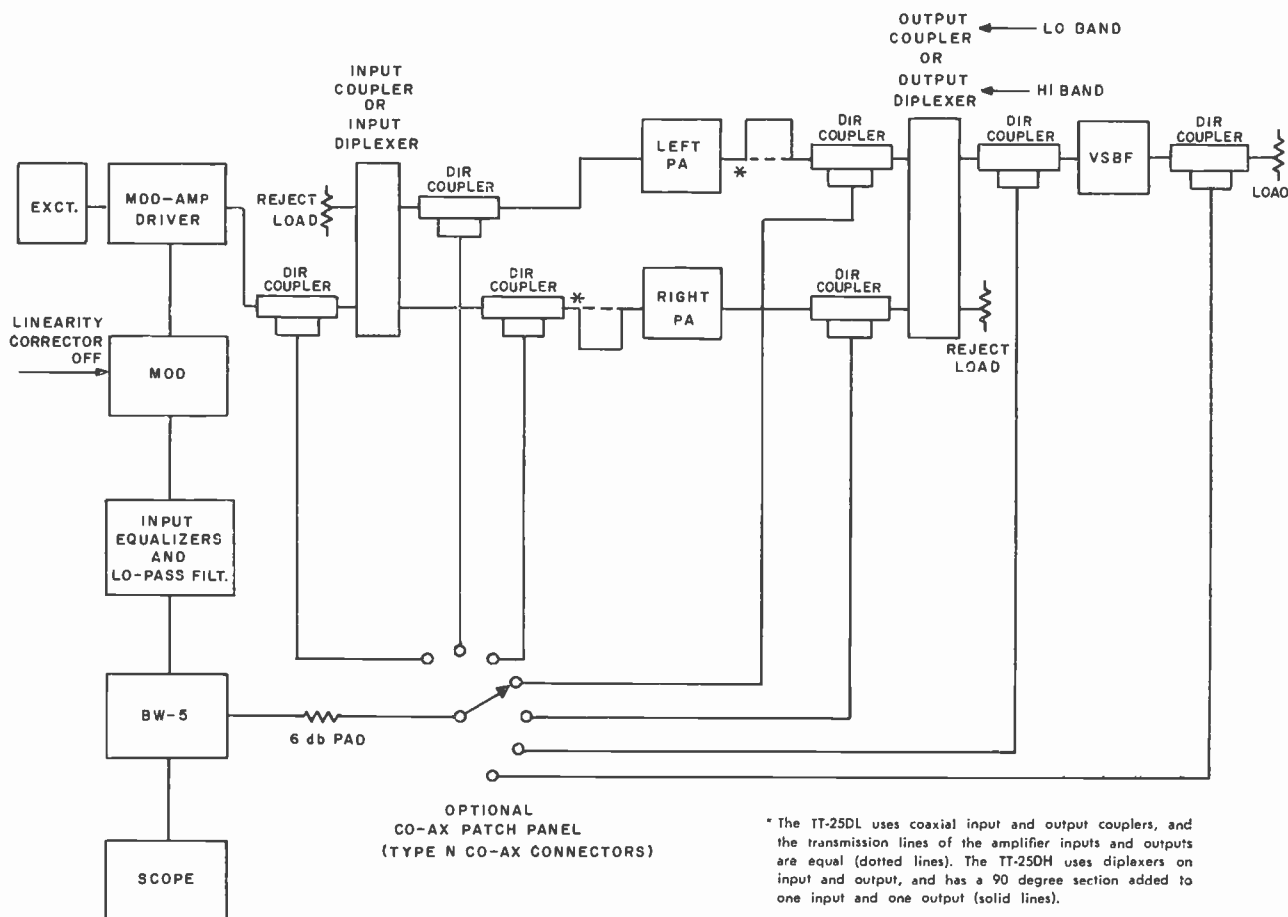

FIG. 14. Block diagram showing points where frequency response is checked in TT-25 DL/DH transmitters utilizing diplexed amplifiers.

Tuning Diplexed Amplifier Transmitters

In the case of transmitters with diplexed amplifiers, tuning is done as for single amplifier transmitters, but there is an additional amplifier to tune and the combining of both.

When the driver tuning is completed (as described under Driver Frequency Response Test) connect it to the input coupler. The input coupler is connected to the left PA amplifier and the right PA portion of the coupler connected to a dummy load (use reject load of the output coupler). Also connect the input coupler to its reject load. The station dummy load is connected to the left PA output through a directional coupler and thru-line wattmeter.

The left PA can now be tuned as described for single amplifier transmitters and checked. When tuning the amplifiers, use

the high-voltage transfer switch in the correct position (i.e., left visual, right visual, etc.).

When the left amplifier is completed, move the dummy load from the output of the left amplifier to the output of the right amplifier. Disconnect the input coupler from the left PA input and move the dummy load from the right to the left port of the input coupler and connect the right PA input to the right PA port of the coupler. Tune the right PA as described for the left one.

Both left and right PA amplifiers should make essentially the same power and have the same response. Reconnect both PA's to the input coupler and connect the reject load to the output coupler as well as the outputs of both amplifiers (normal operating configuration). Connect the station

dummy load to the output of the coupler through the directional coupler and thru-line wattmeter.

When tuning the amplifiers, use the high-voltage transfer switch in the correct position (i.e., left visual, right visual, etc.).

Operate the transfer switch to the BOTH VISUAL position and turn the transmitter on. Check the response and, if necessary, make minor re-adjustments. A directional coupler in each amplifier output and input tells which amplifier needs to be retuned (if at all). Bring the reject power in the input and output coupler to as close to zero as possible by adjusting the input and output tuning and loading controls with loading varied to control output. While doing this, keep the response as indicated on the directional coupler in the input of the amplifier as it was before using the loading

controls to reduce reject power. How much input re-adjustment is required to bring reject power to zero depends on how well the left and right PA's are tuned for power output versus input.

For UHF transmitters using diplexed PA's, the same tuning procedures apply, except to get reject power to zero the power output is varied differently.

For transmitters using klystrons, the power is varied by tuning the cavities for equal black level power from the klystrons, keeping the proper response, and adjusting the line stretcher (phase adjustment) for minimum reject power.

In UHF transmitters using tubes and cavities, power is adjusted using bias adjustment of each amplifier for equal power from the amplifiers and adjusting the line stretchers for minimum reject power.

Tuning Parallel Transmitters

In the case of parallel transmitters, the procedure is the same as diplexed transmitters, except the input coupler is in an earlier stage, before modulation takes place, eliminating the need for using a dummy load to terminate the unused "port" of the input coupler, because the coupler is connected to both transmitters and the one being tuned is turned on, and the other transmitter is left off. The station dummy load is, of course, connected to the output of the transmitter being tuned.

When both transmitters have been properly tuned, they are combined in the output coupler and the station dummy load connected to the coupler output. Achieving zero reject power in this configuration is simpler because power output of the transmitters is adjusted, using each one's excitation control for equal power, and then adjusting the line stretcher for minimum reject power.

Figure 14 shows the set-up for diplexed transmitters, and Fig. 15 shows the set-up for parallel transmitters.

Variation of Output with Brightness

This test is accomplished by adjusting the transmitter for sweep (AC coupled, mid-characteristic, 20 percent peak-to-peak modulation and linearity corrector OFF, if the transmitter has this circuit). Compare the response obtained when the pedestal (or black) level is adjusted for 22.5 percent and 67.5 percent of sync peak. The variations in response must be within ± 1.5 dB for some transmitters and ± 2.0 dB for older transmitters (consult your instruction book for the exact amount for your transmitter).

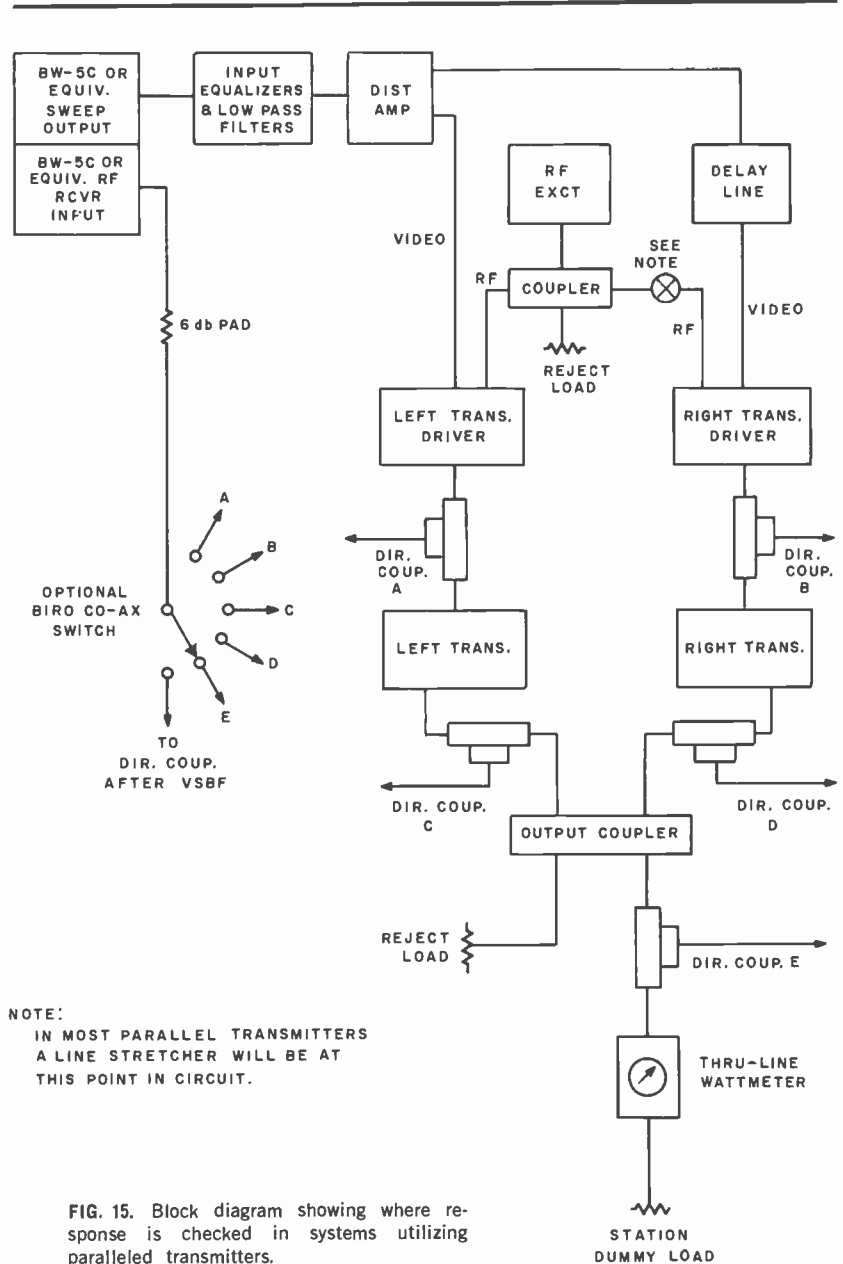

FIG. 15. Block diagram showing where response is checked in systems utilizing paralleled transmitters.

Differential Gain and Phase Test

Transmitter linearity and differential gain and phase is tested and adjusted as the next step. Linearity affects large area color, color saturation and color brightness. Actually no one condition (response, linearity, etc.) is more or less important than another, but the important thing is one condition has to be accomplished before another condition can be met.

To check linearity and differential gain and phase, a modulated (3.58 MHz) stair-step signal is fed to the input equipment and the waveform of the transmitter output from the diode is observed on a waveform monitor (scope) and the modulation adjusted for a 12.5 percent depth of modulation, (set with chopper). The waveform monitor should be equipped with a high-pass filter to facilitate adjusting differen-

tial gain. (Care must be exercised when driving the diode to insure that RF does not overload the device and cause compression in the diode.)

With the high-pass filter in the input line to the waveform monitor, adjust the linearity controls for best differential gain and phase. In the newer transmitters, these adjustments are located on the transmitter modulator chassis (exciter/modulator in new UHF transmitters) and in the older model transmitters a TA-9 stabilizing-amplifier must be used because no linearity adjustments were provided on the transmitter proper. It should be possible to get differential gain to 85 percent or better, and phase to $\pm 7^\circ$ or better.

Some inter-action of differential gain and phase will be experienced so when these are adjusted it is necessary to "go back and forth" until both are at their best point.

This correction circuit (called white stretch in TA-9 stabilizing amplifier and linearity on modulator) consists of several diodes shunted across the cathode resistor of an unbypassed video amplifier. In series with each diode is a resistor. When a diode conducts, it connects the associated resistor across the cathode resistor of the video amplifier, increasing the differential gain. The resistor (bias) on each diode can be adjusted to conduct at a desired brightness level. By individually adjusting the resistors for each diode, a variety of gain-versus-brightness curves are obtainable. Variable trimmer capacitors are connected across the resistors to keep phase angle constant as resistors are added or subtracted by the diode action.

Figure 17 shows the set-up for checking differential gain and phase. From the preceding description, adjust the "linearity" controls (pots) for best differential gain and the trimmer capacitors (marked "phase") for best differential phase. As previously stated, these will inter-act and you must "rock back and forth" on these adjustments.

For both of these tests, a diode demodulator is employed. Use it after the VSBF (or filterplexer) where the -3.58 MHz is suppressed.

One precaution to be observed when using a diode for color performance measurements is that when one sideband is eliminated and the carrier is at full amplitude, the degree of modulation will appear to be suppressed by 6 dB.

Do not adjust the gain controls between white stretch and transmitter modulator when using a TA-9 stab-amp for correction,

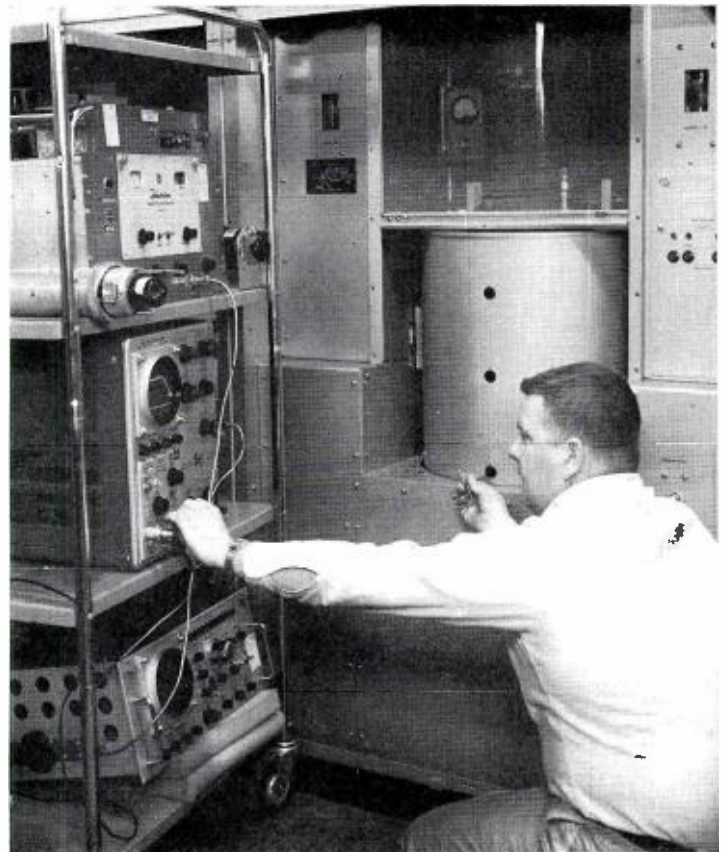

FIG. 16. Tuning the vapor-cooled klystron visual amplifier of the TTU-50C 50 kW UHF transmitter for optimum frequency response.

except to correct for drift in gain of the intervening video stages. If the incoming video level changes, the correcting gain adjustment must be made by a control ahead of white stretch.

Any shift in phase at other brightness levels results in distortion of hue because the receiver 3.58 MHz oscillator is synchronized by the burst at pedestal level. Figure 18 shows wave forms through the transmitting system.

Envelope Delay Test

The final visual transmitter test and adjustment is for envelope delay. The object of this test is to achieve a time match between the luminance and chrominance information and obtain the best waveform for sudden transitions in these channels. This delay characteristic affects the color edges.

Figure 20 is the envelope delay characteristic specified by the FCC. This indicates that the transmitter will correct for its own phase errors and will introduce pre-distortion for high frequency delay of

the *average* receiver. (The receiver is intended to correct for its own low frequency errors.)

This adjustment and measurement can be made using a BW-8A envelope delay measuring set or a square wave generator. The BW-8A is direct reading in microseconds and can therefore prove compliance with FCC requirements, except at low video frequencies. It is also a more sensitive means of adjusting high frequency envelope delay. The square wave generator method will result in better low frequency adjustment, and allows approximation of a uniform delay with the receiver equalizer out, but does not give any delay values.

Using the BW-8A and employing a diode detector after the VSBF (or filterplexer), the phase delay equalizers can be adjusted to give a constant system time delay for frequencies between 2 and 4.2 MHz. This is difficult to adjust due to the missing low frequency reference.

For low frequency delay adjustment, a vestigial sideband demodulator must be

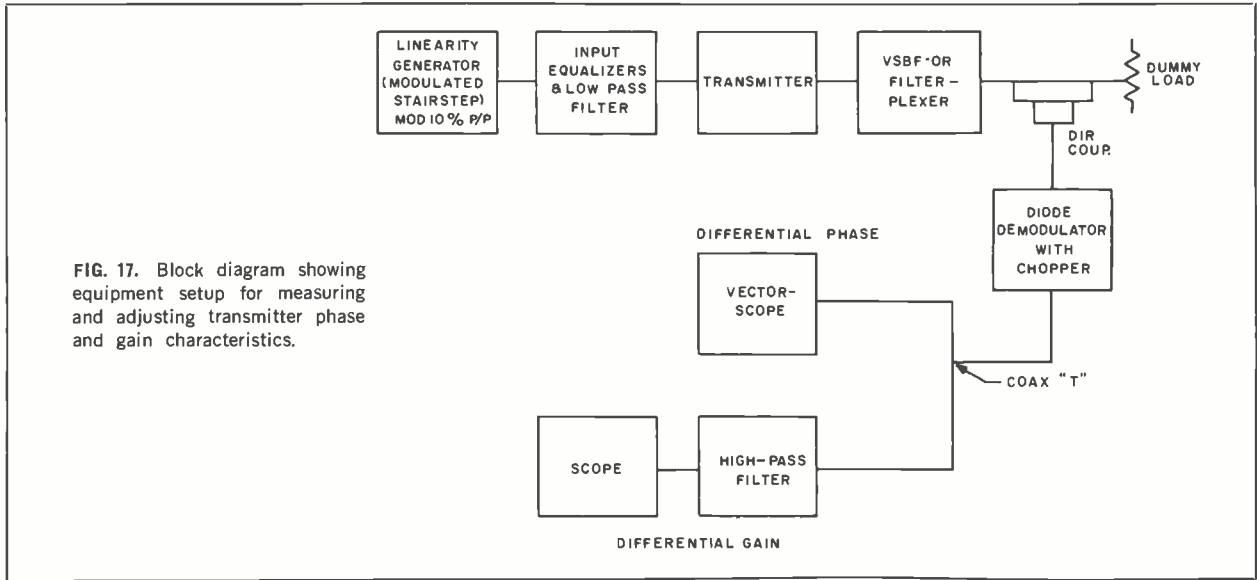

used, and it must be well corrected for its own low frequency phase error. The vestigial sideband demodulator is more convenient than a diode for high frequency delay adjustment, but it would have to have either constant time delay within $\pm .02$ microseconds to 4.2 MHz (sound traps out) or would have to match very closely the inverse of the FCC transmitter delay specification.

Insert a 100 kHz square wave to the system and adjust the low frequency equalizers for the best square wave. In all these tests it is important to keep the depth of modulation low in order to minimize the influence of quadrature components.

Although the square wave response is not greatly altered by considerable change in the adjustment of the high frequency equalizers, one should not consider this unimportant. The 100 kHz presentation is a good measure of performance in the luminance channel only.

To obtain an equally reliable indication of transient response in the chrominance channel, it would be necessary to modulate a 3.58 MHz subcarrier with a 100 kHz square wave to form a new test signal. The output of a regular demodulator would then be followed by a synchronous detector to recover the initial 100 kHz square wave. Under these conditions, adjustment of the

high frequency equalizer would probably be as critical as the low frequency.

Sine² Window Signal

A more recently available test for adjusting the equalizers is the Sine² Window Signal. By using the 2T pulse, adjustment of both low and high frequency is relatively simple, however, like the square wave, it will not prove compliance with FCC specifications, because a numerical value of envelope delay is not possible.

A 2T pulse is Sine² in shape having a half-amplitude duration of a full-period of the nominal upper cut-off frequency of the system under investigation. Thus a 2T

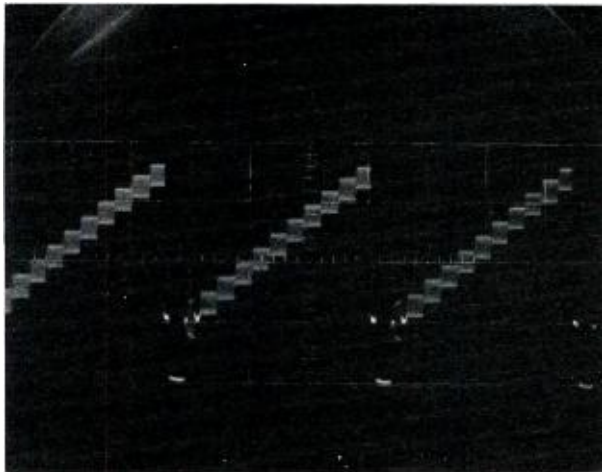

FIG. 18a. Stairstep (modulated) signal at video input to transmitter.

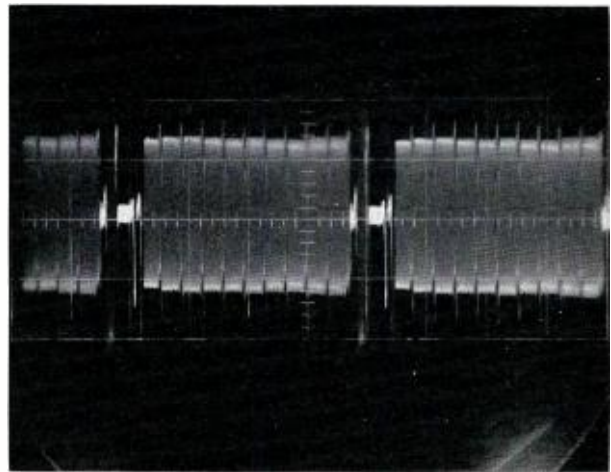
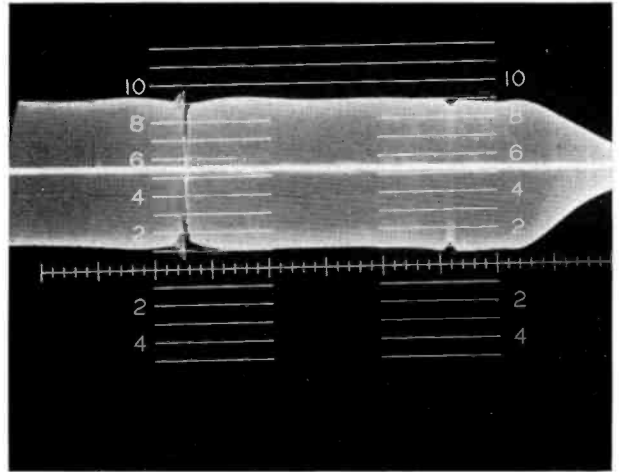

FIG. 18b. Differential gain at modulated amplifier output of TT-6EL.

TV TRANSMITTER PERFORMANCE CURVES

(Marker at 4.2 MHz)

FIG. 19. Shown on these two pages are actual waveforms produced by the 25 kW, Channel 13 TT-25DH transmitter of WTVT-TV and photographed at the station in Tampa, Florida.



(a) Modulator output.

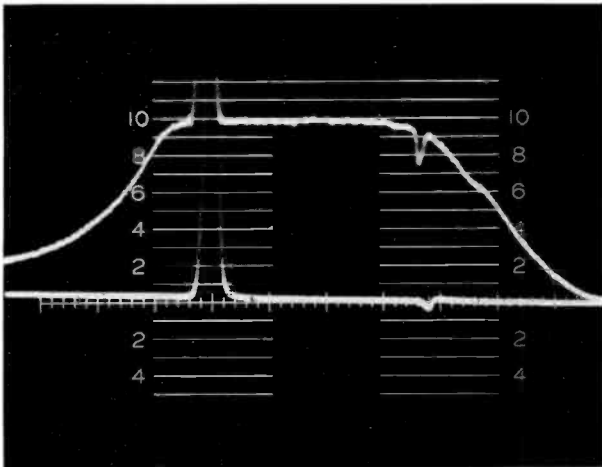

(d) Right PA input.

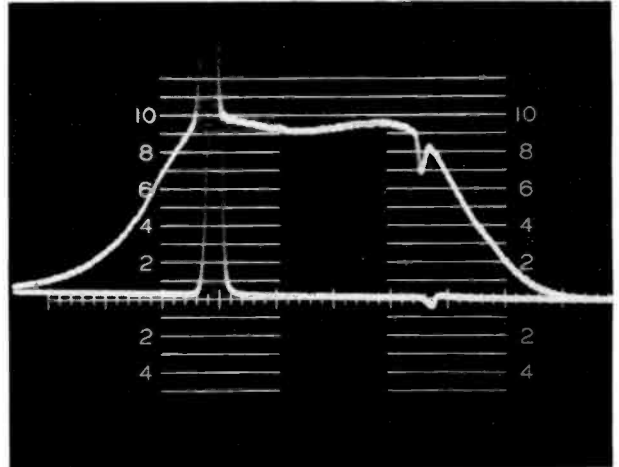

(e) Left PA output.

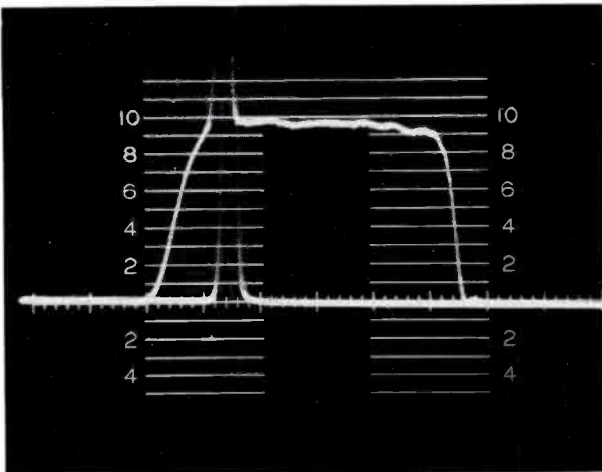

(h) Output of filterplexer.

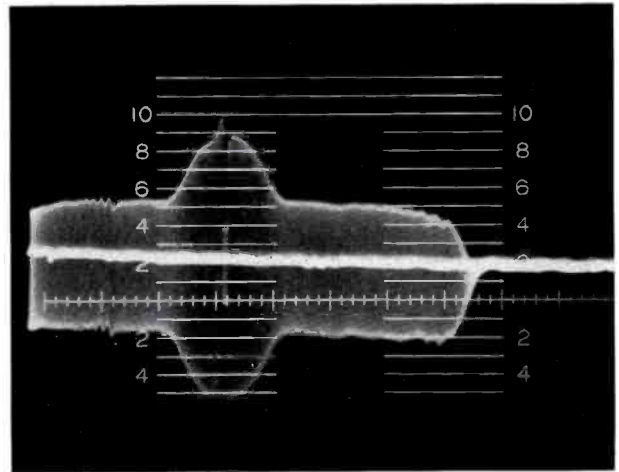

(i) Diode response of filterplexer output.

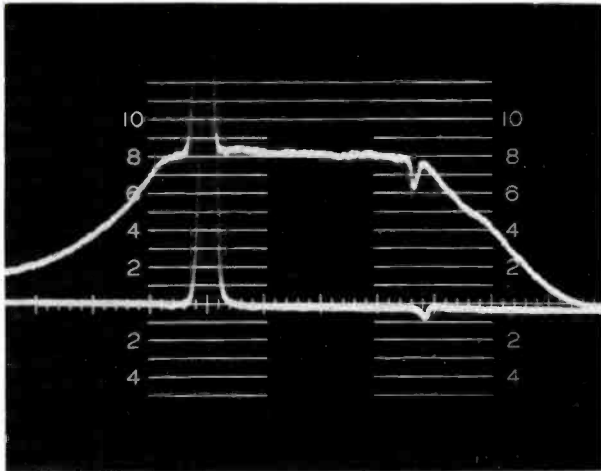

(b) Modulated amplifier output into dummy load.

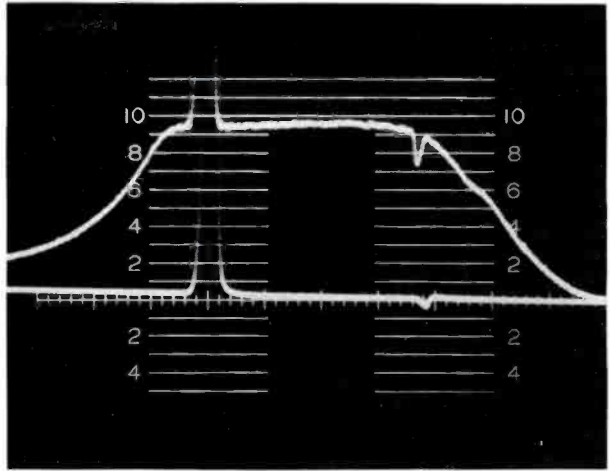

(c) Left PA input.

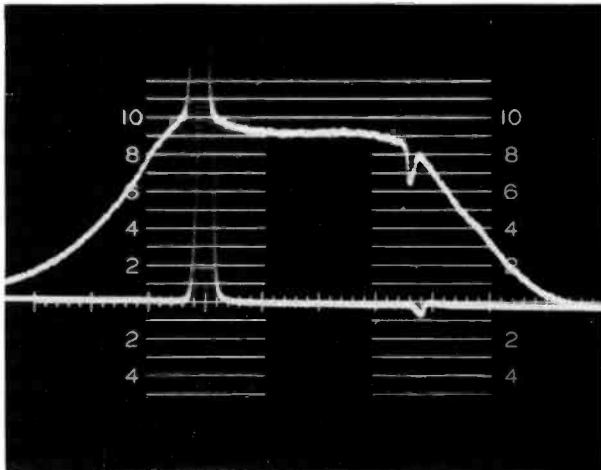

(f) Right PA output.

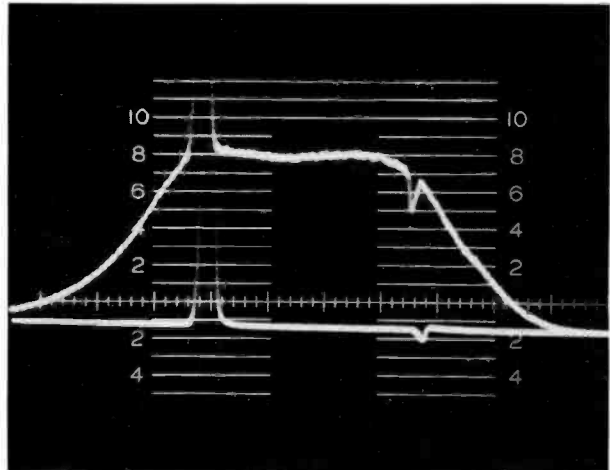

(g) Combined PA output.

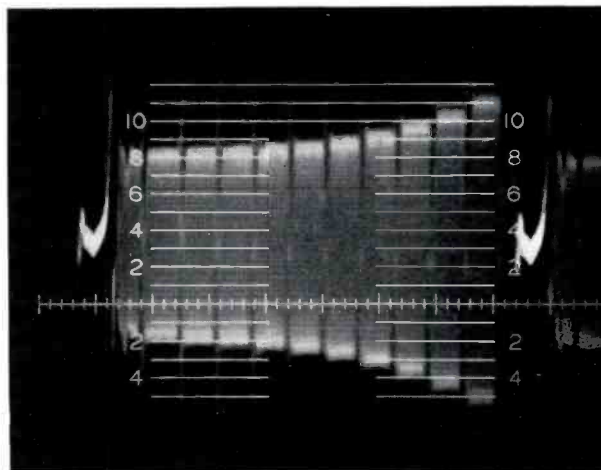

(j) Modulator output — predistorted (differential gain).

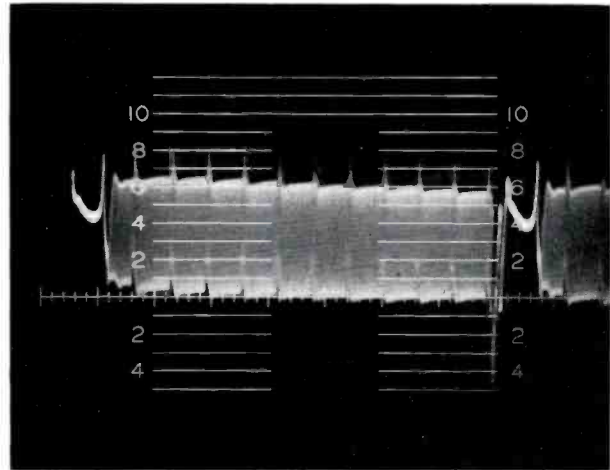

(k) Overall differential gain (differential phase 2.5°).

pulse for a 4 MHz system is a Sine² shaped pulse having a half-amplitude duration of .25 microsecond; the envelope of its significant frequency spectrum is shown in Fig. 21.

A window signal (square wave) of 25 microseconds duration is included with the 2T pulse, the position of which is dictated by the limited horizontal positioning range of the oscilloscope.

The width of the window is determined by the readability of the graticule with the limits for the H-window (2 percent and 4 percent).

A sine² pulse-window generator provides the test signal as illustrated in Fig. 22.

A graticule for use with a Tektronix 524 oscilloscope is available for evaluation with 2 percent and 4 percent limits engraved and is shown in Fig. 23. (A waveform monitor such as Tektronix 529 or Hewlett Packard 191A is also available.)

It is assumed that at this time all other checks have been made and the system linearity is within specifications and a 2T pulse and window signal is applied to the input system.

With the oscilloscope connected to the VSB demodulator (after VSBF or filter-plexer) and the half amplitude points of the H-window transitions coincide with M₁ and M₂ (sweep set at 10 microseconds/CM) the existing black and white levels coincide with B and W, respectively.

The H-window response should fall within the 2 percent or 4 percent limits at the top. The pulse should also fall within the limits shown for it. See Fig. 24. If the pulse does not fall within the limits (down in amplitude), response of the overall system is down. It is this point that the weakness of the pulse-window system as a response check shows up. We show a lack of high-frequency response of the over-all system (including demodulator) but no way (using the pulse-window) to determine which part is at fault. This will be discussed later.

In order to adjust equalizers using the Sine² pulse we will only use the pulse. By setting the oscilloscope sweep speed to .25 micro-seconds (2.5 micro-seconds/CM and 10X magnification). Adjust the vertical position and vertical gain so that the black level is on the horizontal reference line and the top of the 2T pulse coincides with the top of the mask. Using the horizontal positioning control, place the half-amplitude points of the pulse symmetrically about the vertical axis. Adjust the equalizer controls

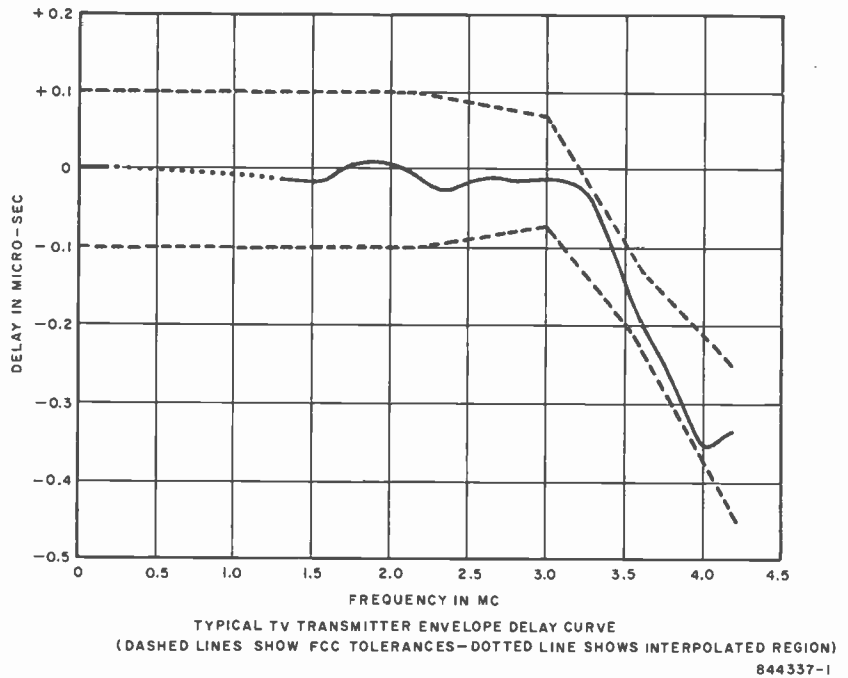

FIG. 20. Curves showing typical envelope delay characteristics as specified by FCC.

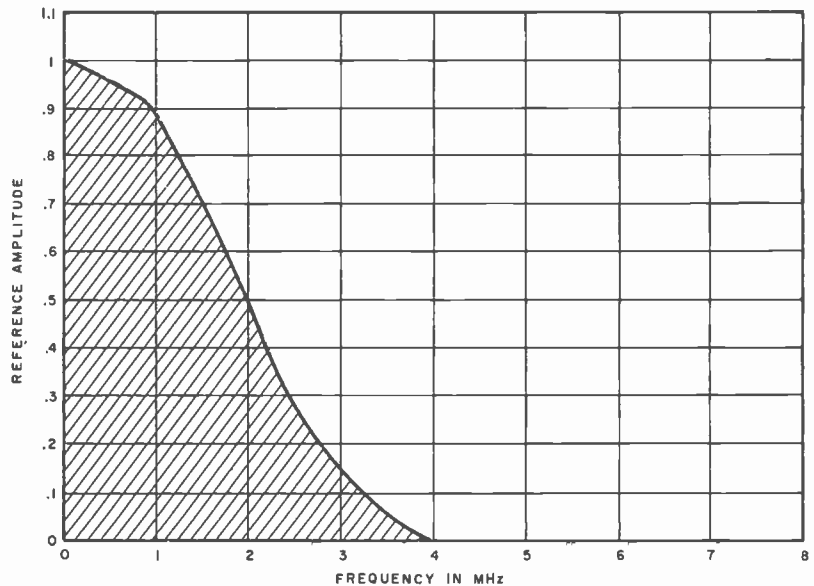

FIG. 21. Curve showing significant frequency spectrum of a 2T pulse.

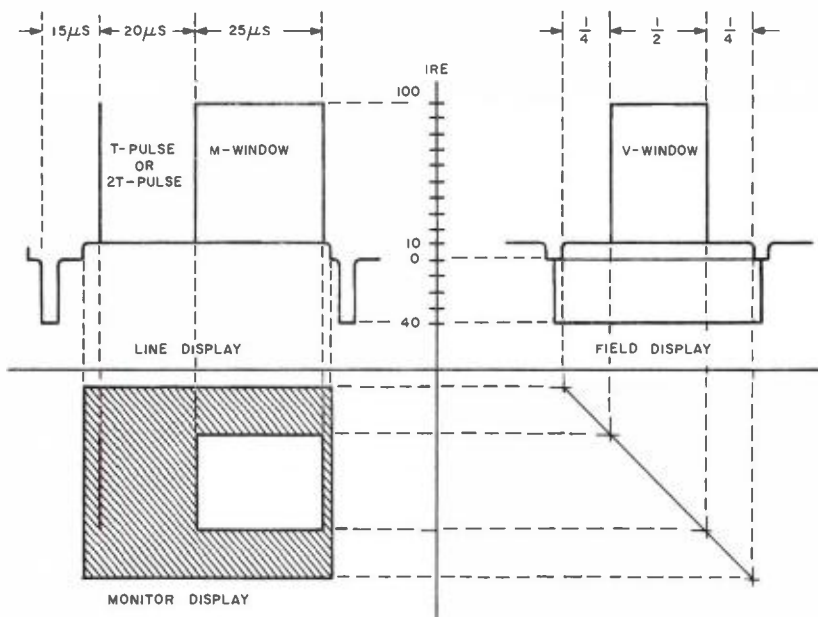

FIG. 22. Test signal provided by a sine² pulse-window generator.

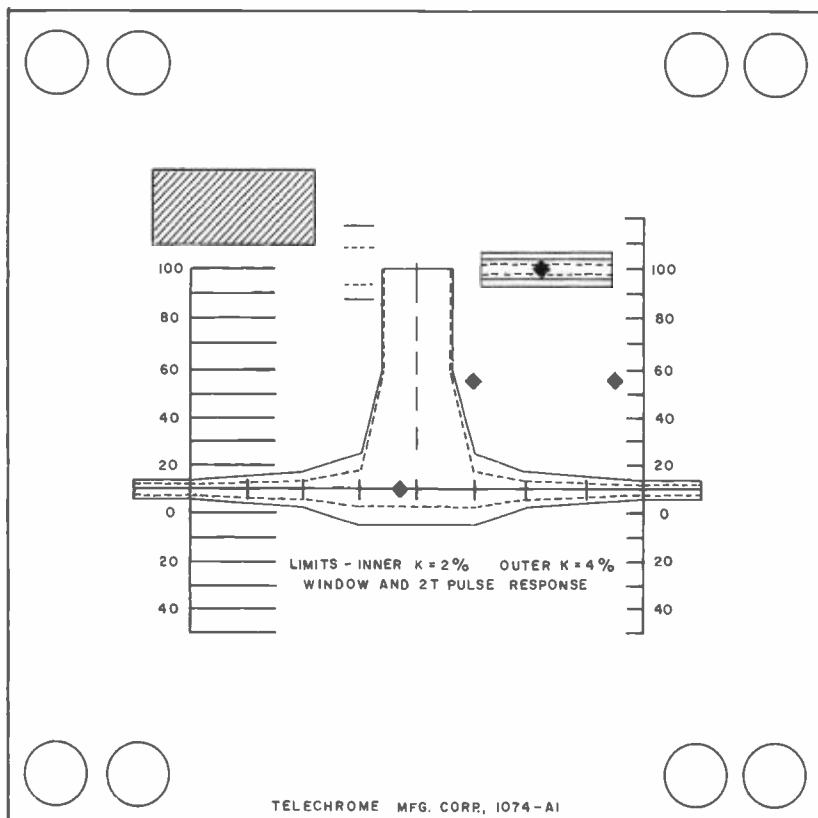

FIG. 23. Sine² graticule available for use with an oscilloscope.

for a symmetrical display of both sides of the pulse at reference line. See Fig. 25. While this will not give a numerical figure of envelope delay, this setting of the equalizers will give you the best that can be achieved.

Earlier in this article it was specified that all equipment be in good operating order. In the above test it can be readily seen that if the demodulator is not flat in its response, the pulse will be down in amplitude with respect to the window. The same condition will exist if the amplitude response of the equalizers should be down.

Conversely if the equalizers are sloped up in response and the demodulator is down in response the pulse would be equal in amplitude to the window indicating flat response when in reality the transmitted signal would be peaked at the high end.

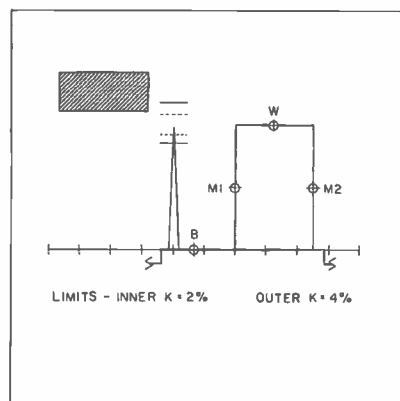

FIG. 24. Limits for window/2T pulse ratio.

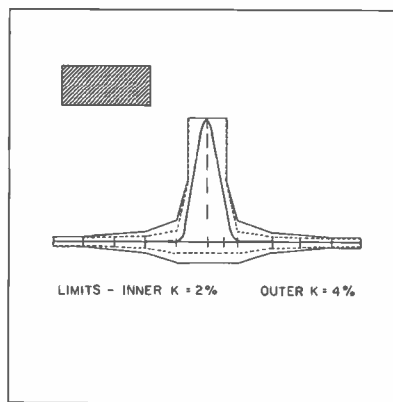

FIG. 25. Limits for 2T pulse response.

A better and more practical use of this signal is after the regular tests are made as described using the sideband response analyzer etc. and you are satisfied that a good and proper signal is being transmitted. Check the over-all system using the 2T pulse and window signal and use the waveform as displayed on the oscilloscope connected to the demodulator as a standard. Use this as a reference for day to day checking looking for any *CHANGE* from the original or test waveform. From this you can analyze which way the system is going and then using the normal tests determine where the change is taking place and correct for it.

Aural Frequency Response

As in the video portion of this article, it is no less important that audio equipment be in good working order. A citation for an aural offense is just as serious as a visual citation.

FCC requires that the standard 75 microsecond time constant pre-emphasis be used in the aural (FM) portion of television transmitters. This curve is shown in Fig. 26. To check this response it is necessary to have an FCC Type-approved modulation monitor and an audio oscillator with attenuator(s) and means of keeping audio voltages at the input of the attenuator constant.

FCC requires also that all audio equipment, from microphone input to transmitter, including limiter amplifiers (with limiting action turned off) be measured for frequency response. This includes the microwave STL also, if such is used.

As a standard pre-emphasis network is a part of the transmitter, it is mandatory that all equipment before the transmitter have a flat response. This equipment should be checked separately and the results recorded in some convenient form (such as on a chart or curve) so that a comparison can be made during routine checks (perhaps monthly). The more components of the system that are isolated for individual testing, the easier it will be to identify the offender should an overall check disclose some abnormality. If the studio and transmitter are together, checking of individual components may be unnecessary. However, testing of systems with separate studio and transmitter locations will be more complex. For this case, the system may be separated into three parts: (1) audio equipment at the studio location; (2) STL equipment or

phone lines; and (3) audio equipment at the transmitter location. This will facilitate checking back to "standard" readings if at a later date the overall checks show trouble.

The audio equipment preceding the transmitter should be prepared for test by feeding a 1,000 Hz signal from the audio oscillator to the microphone input and adjusting the attenuators for a *normal* input level (This will be microphone level). The audio oscillator should have the same output impedance as the microphone input. The Hewlett Packard 206A meets these requirements and is completely self contained with attenuators and a VTVM to keep the signal constant at the attenuator input. Of course, many other units, along with external transmission measuring sets can be used with equal results.

Once the input level is set the remainder of the audio gain controls in the system

should be set to their normal levels. Approximately plus 10 dBm will be required at the transmitter input (± 2 dB) for 100 percent modulation and this level is what should be obtained into a 600 Ohm load with the indicator connected across the load.

Next, the audio oscillator should be checked and the input to the audio system recorded at 1,000 Hz. The audio oscillator is then set to different frequencies from 50 Hz to 15kHz, and while keeping the input to the attenuator constant, the *attenuator only* is adjusted for the same reading as on the output indicator. Record the frequency and the dB *difference* given by the attenuator (plus or minus) from the reading at 1,000 Hz. Always adjust the gain at the input to the audio system; never adjust any gain within the audio system. The result should be the response of the audio system with 1,000 Hz as a reference.

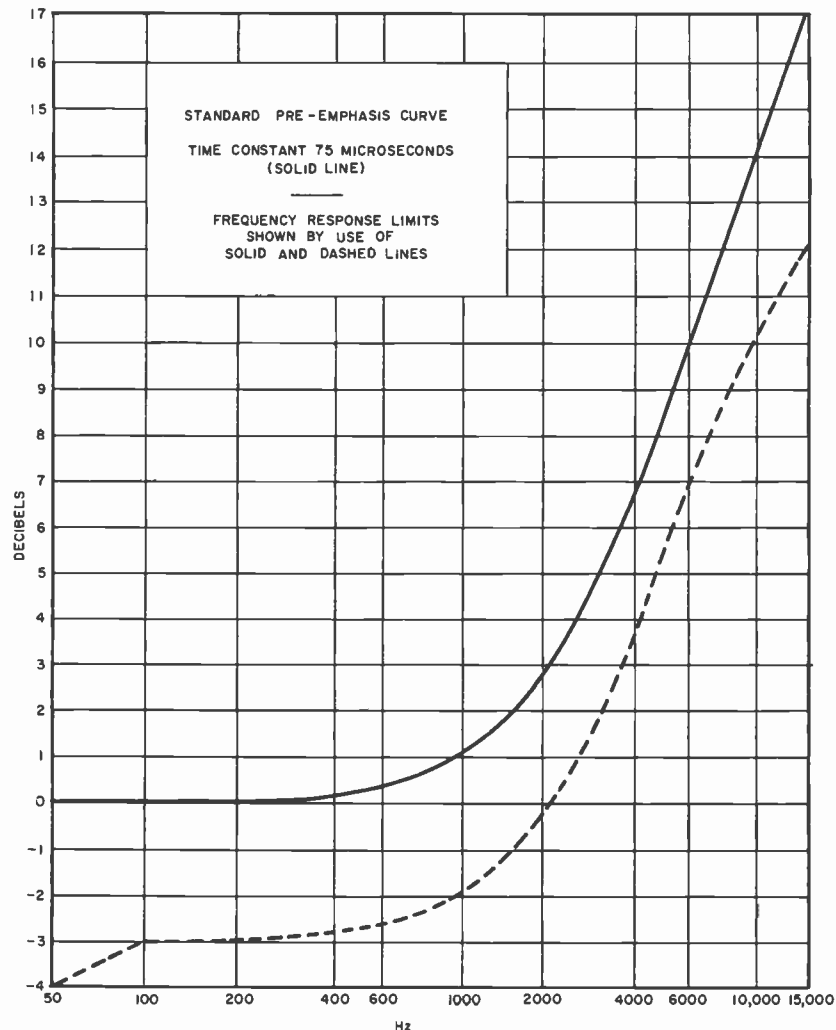

FIG. 26. Standard audio pre-emphasis curve.

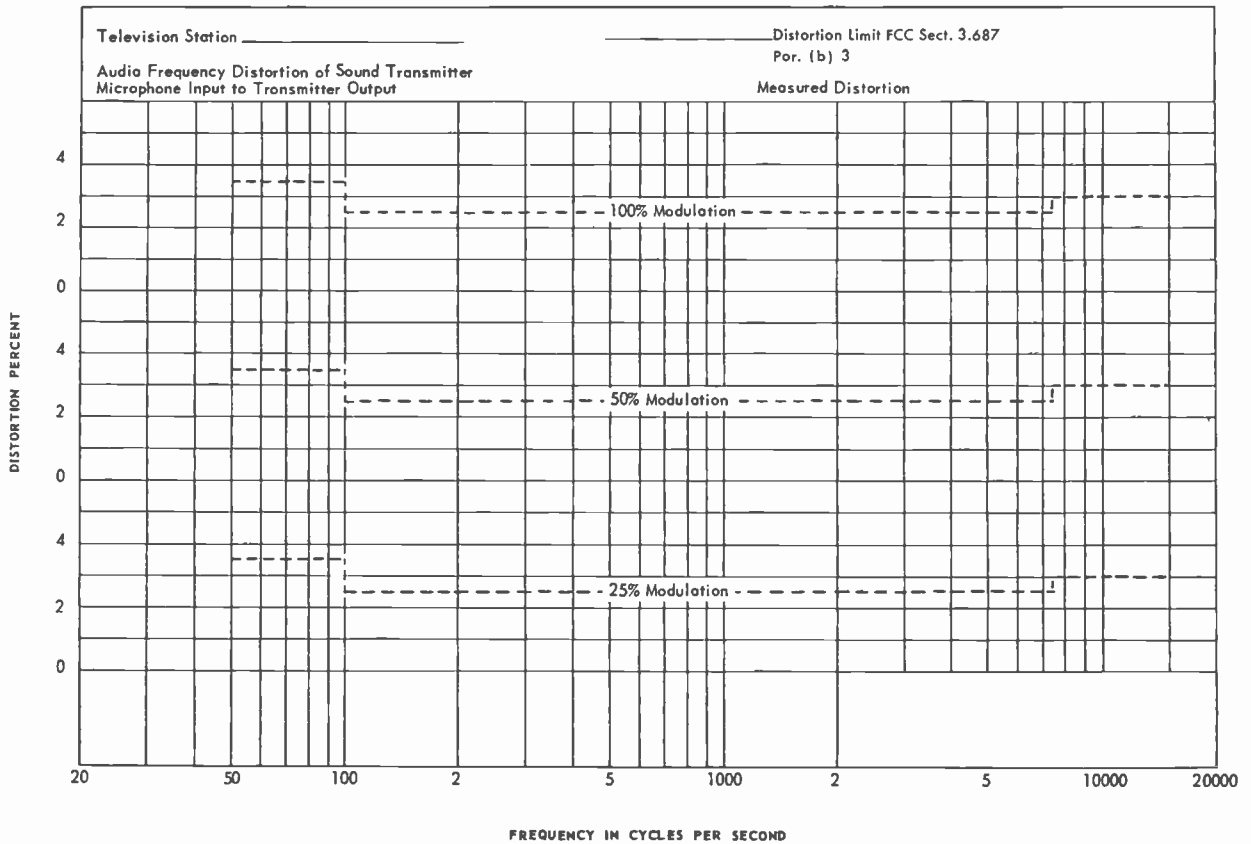

FIG. 27. Audio frequency distortion limits.

For the transmitter audio response measurement, the 600 Ohm load used in the previous test is removed from the audio system and the audio system fed to the transmitter input. The procedure is the same as before except that the response will not be flat due to the pre-emphasis network in the transmitter, and the output indicator will be the modulation monitor. It will be noted from the curve of Fig. 26 that the higher the audio frequency, the less input is required to the audio system.

With the visual transmitter off and the aural transmitter connected into a dummy load and RF wattmeter, apply power and adjust the output for rated power output as indicated on the wattmeter. (The aural transmitter does not require special tuning techniques and equipment as does the visual. However, neutralization of amplifiers and matching of input circuits for maximum power transfer and minimum reflected power is important regardless of power level or type of transmitter. See visual part of this article). The modulation monitor should be checked at this point to insure that the proper RF input levels are being

obtained and that the modulation meter reads 100 percent in the CHECK position.

Using 1,000 Hz from the audio oscillator, the attenuator(s) are adjusted for 100 percent modulation on the modulation monitor, and the input to the audio system (output of attenuators, hence oscillator) is recorded. Then the procedure previously outlined for the checking of the audio system is repeated, that is, the attenuator *difference* from 50 Hz to 15 kHz using the 1,000 Hz reference is recorded. Always adjust for 100 percent modulation as indicated by the modulation meter.

The readings obtained can then be plotted on the curve or chart of Fig. 26, and they should fall within the limits indicated. It should be mentioned that when the points are connected, a smooth curve should be made rather than point-to-point. It is practically impossible to achieve sufficient accuracy in the equipment to get a smooth curve without "splitting" points. This, therefore, is a practical approach.

The above check should be repeated for 50 percent and 25 percent modulation,

again using only the attenuators, not the audio gain controls. In practice, a single reading is usually made at 100 percent modulation. Then, without changing the frequency, the test is made at 50 percent and then 25 percent modulation, thereby completing all three by going through the frequency changing only once. The step-by-step procedure is given here for clarity.

Distortion

Distortion tests are handled in the same manner as response, e.g., distortion measurements are applied to the same sections of the system that were tested for response. In fact, in practice, distortion checks could be made at the same time, rather than separately as described here.

Another piece of test equipment, the distortion analyzer, is added for the distortion check. This unit will "filter out" the frequency that is put into the system under test and measure as a percentage of the original signal, the remaining components (harmonics of original signal) give a quantitative figure for harmonic distortion. Figure 27 is a graph of FCC limits vs frequency from 50 Hz to 15 kHz.

To check the distortion of the audio system (not the transmitter) the distortion analyzer is substituted for the output indicator used in checking response. For each frequency the analyzer range switch is set to the 100 percent position with the function switch in the SET LEVEL position. The input GAIN control of the analyzer is adjusted to get 100 percent indication on the analyzer meter. The function switch is then put in the DISTORTION position and the frequency controls are adjusted to the signal frequency (oscillator frequency). The control is then "rocked" for minimum reading. Then the BALANCE controls (usually two) are adjusted for minimum indication on the meter. There will be some interaction of controls, so a check should be made to be sure the minimum is complete. The meter reading will probably be too low for any value, so the range switch will have to be moved from 100 percent to 30, 10, 3 percent, or until a reading is obtained on the meter. This should be recorded as the percentage distortion together with the frequency which it represents.

Like response measurements, distortion is taken at 100, 50 and 25 percent modulation, so the audio is connected back to the transmitter input and the distortion analyzer is connected to the HIGH Z output of the modulation monitor. Refer to the instruction book for the particular monitor used, since some types employ gain controls and some do not. Older General Radio monitors have the gain control and care must be used not to drive the monitor amplifier into distortion.

The distortion analyzer output of the modulation monitor has a de-emphasis network, the same as a receiver, to compensate

for the pre-emphasis network in the transmitter while the modulation meter is *ahead* of this network.

With the transmitter set up as for response, distortion should be checked the same as described for audio at 100, 50 and 25 percent modulation. As pointed out previously, the distortion checks will in all likelihood be carried out at the same time the response test are made.

FM Noise of Aural Transmitter

This measurement is made with the set up the same as for the distortion tests. With a 1,000 Hz signal fed into the system, adjustments are made for 100 percent modulation as before. The distortion analyzer is adjusted for 100 percent in the SET LEVEL position as before, after which the audio signal is removed and the audio system is terminated in a resistance equal to its characteristic impedance. The distortion meter function switch is put in NOISE position and the range switch adjusted using the dB readings until a reading is obtained. The (FM) noise figure in minus dB is obtained using the meter reading in dB and the dB reading of the range switch, plus 20 dB (amount to be added due to NOISE position of function switch being used). This figure should be about -55 dB or better.

AM Noise of Aural Transmitter

This test is made with the same set up (100 percent modulation) as for FM noise except that the output indicator is an RF diode (visual monitor diode rather than ordinary diode, especially at UHF) coupled to the transmitter output. Using a DC meter the output voltage is measured, multiplied by 0.707 and recorded. Then, using an AC voltmeter, an audio oscillator is set

at 400 to 1,000 Hz for this resultant voltage which is fed into the distortion analyzer in the SET LEVEL position for a 100 percent reading. The oscillator is then disconnected and the distortion analyzer input is connected to the diode output *without changing* the input level. The function switch is then set to NOISE and the range switch for a suitable reading on the meter. The meter and range switch readings are then added as in FM noise tests to obtain the AM noise figure, which should be -50 dB or better.

Conclusion

The testing of a complete television system involves many components, and the visual part of this article covers only the transmitter. It must be kept in mind that a poor video signal going into the transmitter cannot be made to look good coming out. Therefore, video signals arriving at the transmitter should also receive careful checking.

No amount of attention given to tuning, linearity and phase and gain characteristics means anything to a transmitter that has gone off the air because of component failure. Connections to relays, contactors and transformers should be checked periodically. They sometimes work loose causing high resistance contact and possible trouble. Water hoses, pumps and heat exchangers may need attention. Blowers and motors should be lubricated where necessary and on a regular basis. Air filters and blower impellers should be checked for dirt. Dirt can cause more than its share of trouble. The transmitter and other equipment should be kept clean. All parts of the transmitting system have equal importance. With the proper care all will serve the owner well.



FIG. 1. Beautiful new building now occupied by KHQ-TV.

KHQ-TV UPDATES COLOR FACILITIES

Employs TK-42 Cameras with TR-5 for Color Tape
and TK-27 for Color Film to Provide System
for Studio and Remote Programs and Commercials

by DEE WAYMIRE, *Chief Engineer*
KHQ-TV, Spokane, Washington

KHQ-TV, in Spokane, Washington, began operation on December 8, 1952 with the first 100,000 watt operation in the United States. This was just the start of a long list of firsts for this progressive station that serves the large Inland Empire area.

Color Since 1954

The first color transmitted by KHQ-TV was on September 23, 1954, with a regular series of scenery slides, commentary and background music. An RCA flying spot scanner was used until January 23, 1955, when a TK-26, 3V film chain was installed.

The following year, on April 24, 1956, live local color was introduced to Spokane with two TK-41 cameras. Since that time KHQ-TV has supplied the Inland Empire with color coverage of most of the major

events in the area. Many of these programs were recorded on video tape, in color, for playback at a later date. This was accomplished with the addition, in 1960, of the RCA heterodyne color system to one of the TRT-1A tape machines.

In 1964 and 1965 when the demand for color was in full swing, KHQ was already transmitting much of its local programming in color.

Adding New Generation Color

In June of 1965 an RCA TK-27 film chain was installed which has proved a welcome addition, especially in the technical department, with the ease of maintaining consistent high quality with a minimum of maintenance.

In November of 1965 an RCA TR-5 video tape machine equipped with an

electronic splicer was installed. With this machine KHQ-TV, for the first time, was able to go anywhere and record in full color with comparative ease. The versatility of this combination is very good and has come into daily use in the studio as well as being used for remotes.

Since one of the TRT-1A video tape machines was already equipped with a heterodyne color recovery system, it was a simple matter to not only record color of high quality on the TR-5, but also to play back color on this machine through the heterodyne color electronics, with the same quality of performance as with the TRT-1A machines.

TK-42 Equipped for Remotes

In August of 1966, two RCA TK-42 cameras arrived. Since these cameras would be used on remote locations, as

FIG. 2. Two TK-42 Camera controls installed at KHQ-TV. Auxiliary equipment is mounted in these cabinets.

well as in the studio, some way of easily moving the equipment out of the studio needed to be devised. This was accomplished by mounting all of the auxiliary equipment, along with the controls and monitoring equipment, in an RCA console housing. The arrangement has proved to be quite satisfactory both from the ease of initial installation and the ability to take it out on remotes.

On September 10, the first major studio production using the TK-42 camera was recorded on video tape, for playback the following week. Sponsors of this show were highly pleased with the sharpness of the pictures, not just in color but also black and white.

TK-42 Goes to the Fair

The following week KHQ-TV went to the fair. This was the first time out of the studios with a TK-42. Since coverage of the fair was to be recorded for playback the following day, only one TK-42 and the TR-5 were taken on the remote. The camera itself was mounted in the back of a pickup truck for easy mobility around the fairgrounds. Because of the low power requirements, AC power outlets

FIG. 3. Scene at KHQ-TV loading dock, as TK-42 and TR-5 go to the Fair. All equipment necessary is in view, including TM-27 color monitor, small air pump for air bearing on TR-5, and solid-state sync gen complete with color standard built by KHQ technical staff.

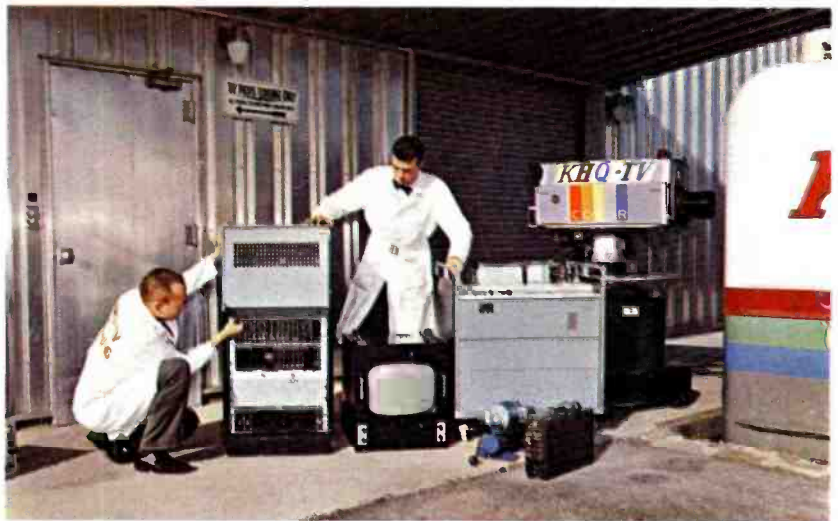

throughout the fairgrounds were readily available. The equipment was moved around the entire large fair area with relative ease and swiftness because of the very short time necessary to get the camera and tape machine going again, after shutdown for a change in power. By using the electronic splicer on the TR-5 tape machine, a one hour show was built completely covering the fair events for a whole day in a way that had the appearance of multi-camera coverage.

FIG. 4. With a single TK-42 and the TR-5, power requirements were so small that one could move almost at will around the many acres covered by the Fair. By using the electronic splicer on the TR-5, a show was built a section at a time and when played back, had the appearance of multi-camera coverage.

As can be seen in Fig. 3, the equipment requirements were quite small. There is the camera itself, the TM-17 color monitor, the TR-5, the camera auxiliary is complete in the console housing, the small air pump is for the air bearing in the TR-5, and, finally, the small brown box is a solid state sync generator, complete with burst flag and color standard built by KHQ-TV station engineers.

This remote was done with considerably fewer problems than ever before. After arrival at the fairgrounds, tape recordings were being made in less than half an hour. With the TR-5 the microwave problems and communications with the studio were eliminated, thereby saving a great deal of time.

TK-42 Camera Alignment

The TK-42's are lined up pretty much by the book, since there is very little else to do. However, we use more light than the 250 ft. candles suggested in the



FIGS. 5 - 6 - 7. TK-42 Cameras in action during first large studio production. See below on Starlit Stairway.

STARLIT STAIRWAY COMES TO Q-6 IN COLOR

Starlit Stairway, for 13 years a variety children's talent show in Spokane, opened its 14th season by moving to KHQ-TV, Channel Six, Spokane's color television center, on Saturday, September 17 . . . with an all star talent revue.

The show was taped on September 10 for release on the 17th, though all future shows in the series will be live.

Pictures (on these pages) are scenes from the first Starlit Stairway telecast . . . shows KHQ-TV engineers and equipment in action during the first taping of the show September 10.

Master of Ceremonies for the show is Ted Otto, well-known North Central Washington radio and TV personality. The show features talented youngsters, from ages two through eighteen. There are several age groups within these age limits and contestants in each group compete against each other for weekly prizes. At the end of the season, the weekly winners compete for the grand prize.

book. To get what we feel is a better compromise between vidicon lag and noise, we pad the orth channel, also taking out the indoor-outdoor filter, and operating with 300 to 500 foot candles at F-8. (Our studios are equipped for 500 ft. candle lighting since they were designed for use with the TK-41.)

Setup is done after the cameras have been on at least a half hour. This is usually not a complete alignment, mostly a check out to see if the camera is acceptable. Most always a minor adjustment of some kind is necessary. Registration always gets a careful look. Since white and black balance is not necessarily controlled within the camera, these controls are checked with the grey scale chart every time we go to a different set. We also get a quick check on I. O. focus and registration at this time. Most adjustments on the cameras are minor but to keep the cameras at optimum requires an overall check at least once a week. This can take from 15 minutes to an hour or more, depending to a great extent on who is doing the check and what may have gotten out of alignment.

TK-42 is a Breeze

After 10 years of keeping TK-41's in operating condition, the TK-42 so far has been quite a breeze to keep looking good. With the TK-41 you could have a fairly poor looking black and white

picture, sharpness wise, and yet have fair looking color since color seems to enhance in many cases the apparent resolution. With the TK-42, excellent black and white is easily obtained at all times, and that's most of the battle. The color it puts out can be excellent too, depending mostly on the operator. Camera match is no real problem, providing they are set up properly and there is a good operator on the cameras.

The lens system on the TK-42 has proved to be highly adequate in the studios. We used a 3 to 1 zoom for years in the studios and found it to be fairly adequate for most work. Later we added a 10 to 1 and found it to be more than adequate. The 5 to 1 range of the TK-42 is a good in-between zoom that does everything needed up to now. In commercial work where an extremely long zoom is desired, a bit of ingenuity and a splicer on a tape machine makes any length zoom a possibility.

Traveling Matte with TK-42

In one studio a large wall area is painted a blue that is very effective in reflecting nothing but the blue used in the color cameras. By lighting this dark blue wall quite heavily an excellent silhouette of the subject is obtained from the blue channel on the color camera, which is highly suitable for a keying signal for traveling matte effects; except for bright



FIG. 8. The RCA TK-27 color film chain installed at KHQ-TV.

white areas in the subject material, like white shirts. This problem is effectively taken care of by inverting the green channel and mixing it with the signal from the blue channel. The one remaining problem is that this keying signal must be delayed by the amount of delay occurring in the encoder. This is done with a variable delay line.

The system just described worked very well with the TK-41 color camera. We were apprehensive of obtaining comparable results from the TK-42. We needed a quick way to try out the system on a TK-42 and found a simple way to do it. We needed the blue and green camera signals and found them available in the matrix module with an output readily available at either the monitor or scope feeds via the RGBM switches. Already available in the module was inverted green. Also available in the matrix module was extra relay contacts that were utilized in a manner that the blue channel mixed with inverted green appeared at the monitor or scope, whenever the blue and green relays were closed at the same time. This output was fed to the variable delay line and then to the effects amplifier. It was found necessary to limit the bandwidth of this keying signal to approximately $1\frac{1}{2}$ MHz because of the noise in the blue channel. This system does produce an acceptable keying signal and allows us to get most any kind of traveling matte effects that the production department comes up with.

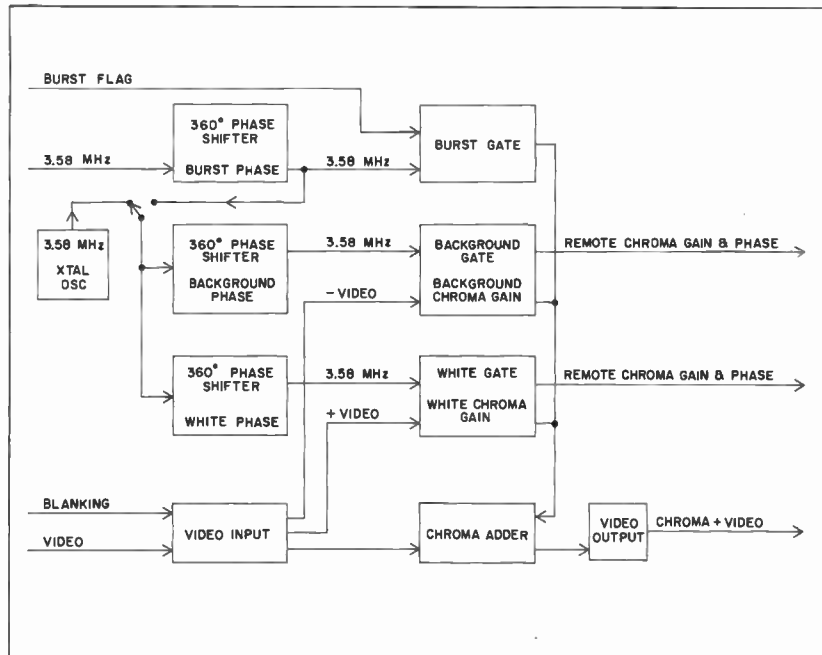

FIG. 9. Synthetic color encoder designed and built by KHQ-TV engineers.

TR-5 For Color Tape

Our TR-5 video tape machine has turned out to be quite a little workhorse. Most all video tape recordings for commercials and some programs are done on this machine, mainly because it is equipped with an electronic splicer. The splicer is an invaluable aid in the production of many commercials. It allows a commercial or a program to be easily put together a section at a time and at the same time achieve effects normally only associated with film commercials. Once a commercial is completed it is played back on the same TR-5, in color, using the heterodyne color processor.

Lighting for Color

We have about half quartz iodide and half tungsten lights. Most all front lighting is done with quartz, top lighting with tungsten. We don't appear to run into any problems using them together in this manner. We tried converting some of our old tungsten fixtures to quartz and found, at least the ones we tried, highly unsatisfactory. The scoops we have that were designed for quartz give a narrower beam at the same distance as the tungsten scoops, also a 1-KW quartz fixture puts out considerable more light than a 1500-watt tungsten. Though the beam is narrow, it is quite flat. Of course, if a wider beam is desired they can be moved back.

On election night, one of our newsmen spent several hours under the quartz lights in the studio. The next morning he looked like he had spent the day on the beach in bright sunshine. None of us here have ever seen anything like it.

TK-27 Color Film Stability

An item that may be of interest on this film camera. We now have 18 months of steady operation on this chain still using the original tubes. Still no sign of them failing. Also, this chain has not been shut down for the past 8 months and we have found that it's already good stability is improved by doing this, to quite a considerable amount. The same thing is being tried with the TK-42 cameras, however, it's still too early to evaluate the effect.

Color From PK-301 Vidicon Camera

In addition to network, color video tape, film and live cameras, KHQ-TV has taken every opportunity to add a bit of color to even the two black and white vidicon cameras, which we find are highly useful even in an all-color station. One vidicon, a PK-301, is used to pick up what

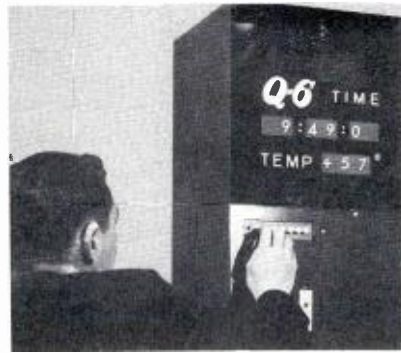

FIG. 10. Time and temperature are displayed by computer type readouts, picked up by a vidicon camera and fed to two color encoders for producing a two-color picture.

call our time and temperature display. The other is used in the studio for title cards, roll-ups, prices, etc. The output of these cameras is fed into two solid state color encoders designed and built by the KHQ-TV engineering department.

Before describing the color encoders a few words about the time and temperature display also designed and built by KHQ-TV engineers. As can be seen by the photo, the time and temperature is displayed by computer type readouts. Readout of the time is accomplished in a series of ring counters which are sampled for time accuracy each minute by a pulse from the station's master clock, which in turn is referenced each hour to WWV. This assures that the time presented is automatically kept accurate to a split second. Temperature is read out automatically from a thermistor mounted outside the building and is part of a bridge circuit and servo system. Conversion to digital display is by mechanical switching. The whole display is clean cut, modern and just a bit different than the clock on the wall. It is automatic, always available at the switcher button, and is

used at every station break. Lights on the readouts are hooked into the tally system on the switcher to prevent burn-in on the vidicon.

As mentioned before, the output of the PK-301 picking up this display is fed to one of the color encoders and is presented on the air in a variety of two color combinations and of varying saturation, depending on the selection made by the operator.

Nothing new about artificially coloring black and white displays of this nature, if you happen to have an old encoder around. However, it is a bit cumbersome with a regular encoder because of having to manipulate the polarity and amplitudes of the three signals derived from the original signal in order to get the colors and saturation desired.

Since the two-color encoder was all that we wanted for this specific purpose, we designed and built one using an approach specifically for this purpose. The block diagram shows how we built the two-color encoder. Remote control of the phase shifting, chroma saturation, and video level is done with simple raysistors. Also included in one of the artificial color encoders is a 3.58 crystal oscillator whose rate of change in relation to the 3.58 station standard can be adjusted manually. When this is the source of 3.58 to the color gates, very interesting changing color effects can be obtained depending on how fast the rate of change occurs and in which direction.

Color Monitors

Since professional type high quality color monitors are quite expensive it is hard to justify having large numbers of these monitors around the station at non-critical locations. We have a few of these monitors at critical locations and look on them as another piece of high quality test equipment. In many locations a regular home color receiver is quite adequate and can easily be fed from composite video using a simple diode modulator with a single transistor oscillator supplying the channel frequency. The diode can be gated by a standard one volt video signal. Depth of modulation is controlled by the amount of RF fed to the diode gate. A dropping resistor capacitor, and Zener diode allows DC for the transistor to be taken from the TV set. By mounting this small unit in a shielded container near the set tuner, several sets may be operated in close proximity to one another without interference.

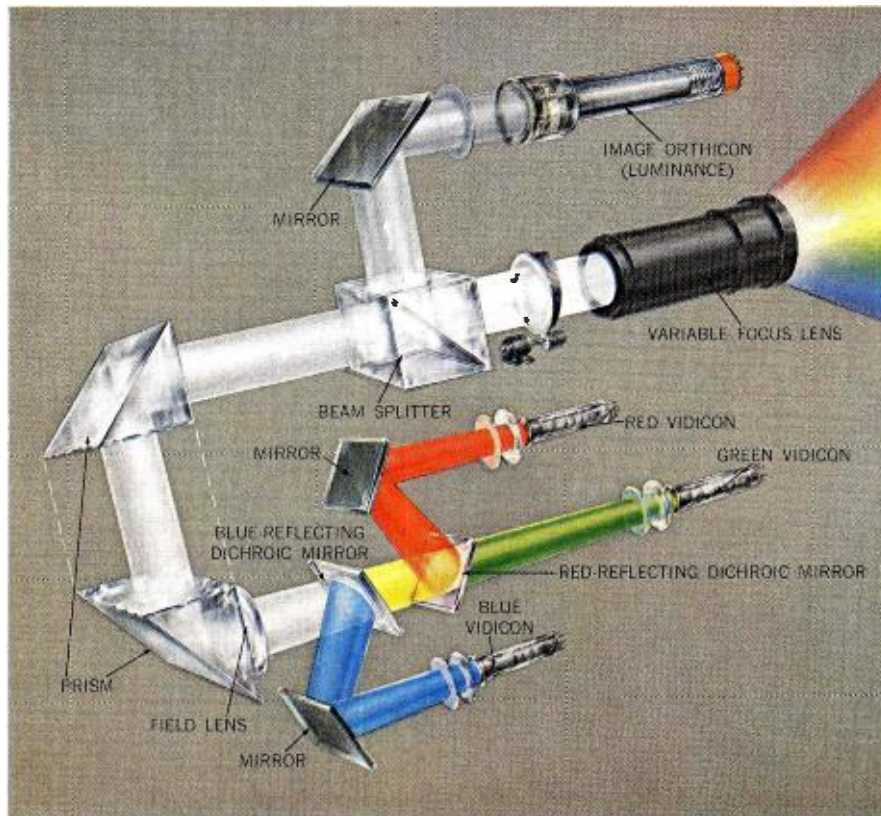

FOUR TUBE, SEPARATE LUMINANCE COLOR TELEVISION CAMERA

by CHARLES J. HIRSCH
Corporate Staff Research and Engineering

I. Introduction

This paper discusses the properties of a four-tube separate-luminance camera, which uses one image-orthicon to generate the *luminance signal* (Y) and three vidicon-type pick-up tubes to generate the *chrominance signal*. The performance is compared with that of three-tube cameras which use three tubes to generate both signals. For simplicity, these two types of cameras are referred to as YRGB and RGB respectively, according to the function of the individual pick-up tubes.

The differences in the performance of the two cameras results from the facts that 1) the YRGB camera generates the two signals by independent means, and 2) the YRGB and RGB cameras generate luminance signals which differ in important characteristics, because they are gamma-corrected differently.

II. General

The pick-up tubes of television cameras generate signals whose amplitude depends on the intensity of the light incident on the camera. Conversely, television picture tubes emit light whose intensity depends on the strength of the impressed signal.

For monochrome television, the light is usually panchromatic or, in the case of the camera, may be adjusted to the same spectral characteristic as that of the sensitivity of the eye, so that the camera response is then proportional to luminance.

For color television, the total incident light is resolved into three color components, called primaries, and electrical signals proportional to the intensities of these primaries are generated. The primaries chosen usually are red (R), green (G), and blue (B). In the case of the YRGB camera, the luminance (Y) is also picked up separately.

To achieve compatibility, as explained in the next section, and for economy of bandwidth in transmission, the primary signals are combined (encoded) into a luminance signal to which a modulated chrominance subcarrier is added. These signals, when picked up by a color receiver, are decoded to the original red, green, and blue primary signals which, when impressed on the picture tube, produce red, green, and blue light which together add to reproduce the color incident on the camera.

III. Compatibility

In order that color television transmission be received by both monochrome and color receivers, the color image is resolved into a high-definition monochrome picture to which low-definition coloring is added. The monochrome picture is transmitted by a luminance signal, designated by the letter Y, which reproduces the relative brightness of each picture element. The coloring is transmitted by a chrominance signal. Monochrome receivers use only the luminance signal to produce black and white pictures. Color receivers combine both signals to produce color pictures.

The amplitude of the chrominance signal is proportional to the amount of color present (saturation). The amplitude is zero for monochrome parts of color pictures, so that the color signal for a monochrome picture does not differ appreciably from the standard monochrome signal.

Because the monochrome component of a color picture carries the fine detail and contrast for both monochrome and color pictures, the luminance signal is transmitted with the greatest bandwidth practicable (about 4 mcs.). The coloring requires much less detail, so that the chrominance signal is transmitted with only $\frac{1}{3}$ to $\frac{1}{8}$ as much bandwidth as the luminance. This is illustrated by Fig. 1A which shows a sharp color television picture photographed from a color television picture tube. Fig. 1B shows the luminance component of this picture which was obtained by removing the chrominance signal from that which produced Fig. 1A. Note that this picture is also sharp. Fig. 1C shows the chrominance component of Fig. 1A. It was obtained by removing the luminance signal and adjusting the brightness. Note that it is less sharp.

Because they represent the colorimetric difference between the composite color signal and the luminance signal, chrominance and its components are often referred to as *color-difference* signals.

To produce a compatible picture, a luminance signal (Y) is produced:

1. In the case of the RGB cameras, by combining the R, G, and B primary signals according to their relative contribution to luminance (Y) as follows:

$$Y = 0.30R + 0.59G + 0.11B \text{ (neglecting gamma-correction) where: } 0.30, 0.59, \text{ and } 0.11 \text{ are the relative contributions to luminance of the NTSC primaries centered on Ill. C. Note that } 0.30 + 0.59 + 0.11 = 1.00$$

2. In the case of YRGB cameras, by using a separate pick-up tube which generates a signal proportional to the total luminance of the picture element being scanned.

The color-difference components of the chrominance signal (R-Y), (G-Y), and (B-Y) are then formed from the R, G, B.

* The chrominance-only picture has no brightness contrast and the brightness level is theoretically zero. In order to photograph this picture the brightness was raised to a useable level. This introduced some colorimetric distortion.



FIG. 1A. Composite Color Television Picture.



FIG. 1B. Luminance Component of FIG. 1A.



FIG. 1C. Chrominance Component of FIG. 1A.*



Biography of the Author

CHARLES J. HIRSCH was born in Pittsburgh, Pa., on October 25, 1902. He received the B.A. and E.E. degrees from Columbia University, New York, N.Y., in 1923 and 1925, respectively.

By 1941 he had been Chief Engineer of radio companies in France, Italy, and the United

States. In 1941 he joined Hazeltine Corporation, Little Neck, N.Y., and rose to the ranks of Chief Engineer and Executive Vice President of Hazeltine Research Corporation in 1956. His activities at Hazeltine concerned themselves with the development of color television and of all phases of secondary radar such as IFF, beacons, and DME. From 1953 to 1955 he was located in London as Technical Director of a Navy off-shore procurement project to manufacture IFF for NATO in the United Kingdom. Since 1959 he has been Administrative Engineer on the Corporate Staff of the Vice President for Research and Engineering at RCA, Princeton, N.J., where he coordinates the research and engineering activities of the Home Instrument, Record, and Custom Aviation Divisions with the rest of the corporation. He is the author of articles on air navigation, IFF, DME, analog computers, color television, and stereophonic sound, and has received 25 patents in these fields.

He was Secretary of Panel 13 of the National Television Systems Committee (NTSC) that established color television standards; Advisor-Observer for the Color Television Committee of the British Radio Equipment Manufacturers Association (BREMA); Chair-

man of Panel I of the National Stereophonic Radio Committee (NSRC) whose studies resulted in the adoption of the present FM-multiplex stereo standards by the FCC; and Chairman of the U.S. Department of State's Preparatory Committee for CCIR Study Group XI on Television.

In 1947 he received a certificate of Commendation from the U.S. Navy for contributions during World War II to the development of IFF equipment. He also received Letters of Commendation from the U.S. Department of State for his chairmanship of U.S. Committees, and a token of appreciation in the form of a 16th century map of London, from BREMA. In 1959 he received the IRE-EIA Radio Fall Meeting Plaque for contributions to television and stereophonic standardization.

Mr. Hirsch is a Fellow of the IEEE, of the IEE of Great Britain for which he is the Honorary Secretary in the United States, and of the Radio Club of America. He is a member of SMPTE and of SFER (France). He is a licensed Professional Engineer.

He is Chairman of the Broadcast Television System Committee of the EIA.

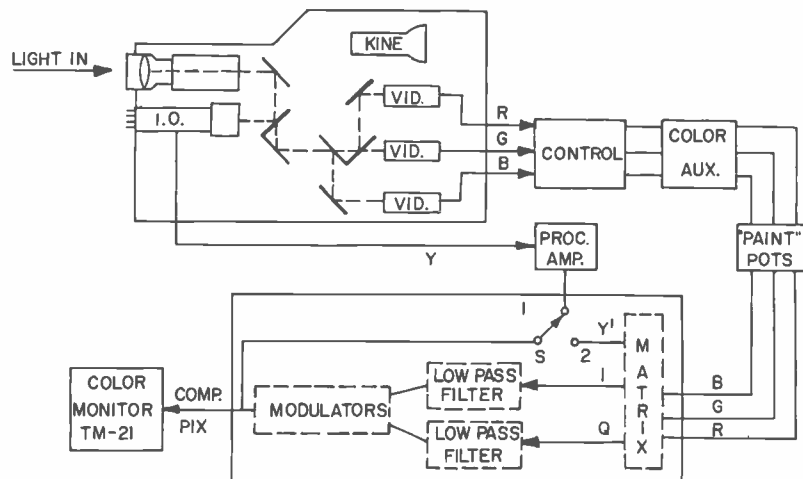

FIG. 2. Block Diagram of a Four Tube Color Camera.

and Y signals. Actually, only two components of chrominance (R-Y) and (B-Y) need to be transmitted because the third (G-Y) can be derived from the other two. Before transmission, these components are translated into I and Q components which are combinations of (R-Y) and (B-Y) as follows:

$$I = 0.74 (R-Y) - 0.27 (B-Y)$$

$$Q = 0.48 (R-Y) + 0.41 (B-Y)$$

The receiver translates I and Q back into (R-Y), (G-Y), and (B-Y) and adds Y to these to reconstitute the three primary signals as follows:

- 1) on the red gun $R-Y + Y = R$ (red primary)
- 2) on the green gun $G-Y + Y = G$ (green primary)
- 3) on the blue gun $B-Y + Y = B$ (blue primary)

which together result in:

$$\text{chrominance} + \text{luminance} = \text{original color}$$

Note that on monochrome $R = G = B = Y$, so that R-Y, G-Y, B-Y, I, and Q vanish.

To repeat, the three-tube camera uses three pick-up tubes (R, G, B) to generate both the luminance and chrominance signals. The four-tube separate-luminance camera, YRGB, uses one pick-up tube solely to generate the luminance signal (Y), and three pick-up tubes (R, G, B) to generate the chrominance signal.

IV. Principle of the YRGB Camera

The principle of the YRGB camera is explained by referring to the block diagram of Fig. 2. The light input to the camera is split into two paths. One path leads to an image-orthicon (I.O.) on whose face the color-image to be televised is focussed. The other path leads to a series of dichroic mirrors (D) which resolve the color picture into red, green, and blue *color-separation* images which are focussed on three vidicon-type pick-up tubes respectively (R, G, B). The four tubes are scanned simultaneously.

The filter in front of the image-orthicon transmits light according to the luminosity function (\bar{y}) so that its instantaneous electrical output is proportional to the luminance (Y) of the picture element being scanned. Simultaneously, signals are obtained from the color-separation vidicons which are proportional to the red, green, and blue (R, G, B) intensity of the corresponding picture element.

The R, G, B outputs of the three vidicon-type tubes are combined to form the chrominance signals, I and Q, and also, if desired, can be combined to form, in addition, luminance signal $Y = 0.30R + 0.59G + 0.11B$.

The camera can be converted from a four-tube, separate-luminance, camera to the usual three-tube type by switch S. When the switch is in position 1, the luminance signal is generated by the separate-luminance tube (I.O.) and the chrominance signal is generated by the three-color separation tubes (R, G, B). When the switch is in position 2, both the luminance and chrominance are generated by the color-separation tubes.

In the case of the R, G, B camera, each of the color-separation pictures should be sharp (say 4 mcs.) because the luminance signal is formed by adding the three together.* This is not the case for the YRGB camera which uses a separate pick-up tube to generate the luminance and whose RGB tubes generate only the chrominance signal which requires no more than 1.5 mcs. of resolution. This independence of the means of generation of the two signals results in advantages for the YRGB camera.

V. Tolerance to Misregistration

For the RGB camera to produce sharp pictures, it is necessary that the corresponding red, green, and blue color-separation images be sharp* and that they be scanned simultaneously, element by element. If the scanning is not simultaneous because the three images are misregistered optically, because the scanning linearity differs between the three tubes, or because of beam bending, the corresponding picture elements overlap and produce a fuzzy composite picture. Also, unevenness in the output of the RGB tubes produces luminance and color shading. For this reason, the RGB camera requires accurate and stable means of keeping the three tubes registered.

Because the YRGB camera uses a single tube to produce the complete luminance signal, its pictures are much freer of such errors.

To compare the effect of misregistration in the RGB and YRGB cameras, the green color-separation image of each camera was displaced by 1% (5 lines) horizontally and vertically from the corresponding red and blue images. This is much more than the misregistration to be expected in practice, but is used to exaggerate the effect for better illustration.

Figures 3A and 3B respectively show the pictures produced by the RGB and YRGB cameras on monochrome receivers. The RGB picture is fuzzy. The YRGB picture is sharp as if nothing had been done to the registration. This is to be expected because the relative misregistration of the RGB tubes does not affect the luminance signal of the YRGB camera which is the only one reproduced by monochrome receivers.

Figures 3C and 3D show the same signals reproduced on color receivers. Again, the RGB picture is fuzzy, while the YRGB picture is sharp. Both pictures have color fringes, but those of the RGB camera are much more visible, being sharper and more separated. This is because each pick-up tube of the RGB camera must produce sharp color-separation pictures to supply luminance as well as color information. In the case of the YRGB camera, the RGB tubes need to supply only *low-resolution* color-separation pictures with *little luminance contrast*, as shown in Fig. 1C. Misregistration is therefore less visible.

VI. Sensitivity

The composite color signal is proportioned according to the *Constant Luminance Principle* which, in the ideal case, requires that all the luminance be carried by the luminance signal and none by the chrominance signal. Since luminance noise is more visible than noise of equal energy in chrominance, the chrominance signal is relatively noise-free, accounting for less than 10% of the camera's noise.

* Actually, the resolution required for each primary picture is proportional to that primary's contribution to the total luminance, so that, strictly speaking, the blue color difference picture need not contribute as much detail as the other two. However, it is not practical to take full advantage of this fact.



FIG. 3A. Monochrome Picture from Misregistered RGB Camera.



FIG. 3B. Monochrome Picture from Misregistered YRGB Camera.



FIG. 3C. Color Picture from Misregistered RGB Camera.



FIG. 3D. Color Picture from Misregistered YRGB Camera.



FIG. 4A. Photo of color TV screen with high noise added to the chrominance channels of RGB camera.



FIG. 4B. Photo of color TV screen showing relative absence of noise when luminance is obtained from noise-free tube.

The immunity of the chrominance signal to camera noise can be shown dramatically by referring to Fig. 2.

With the switch thrown to position 2, so that the luminance signal (Y) is generated from the R, G, B signals, enough external random noise can be added to these signals to produce a very poor picture in a color receiver (see Fig. 4A). If the switch is now thrown to position 1 so that the luminance signal comes from a relatively noise-free source, the noise in the receiver practically disappears (Fig. 4B), even though its amplitude in the chrominance channel (RGB) is as high as in the previous case. (Figures 4A and 4B are photographs of color television pictures on black and white photographic film, whose greater speed allowed a shorter exposure, and therefore produced less integration of the noise.)

VII. Contrast, High-Key Lighting, and Specular Reflections

The light-transfer characteristic of image-orthicons has a knee beyond which there is little or no increase in signal. Some RGB cameras use three such pick-up tubes. To maintain color balance, it is therefore important to limit the contrast range of such cameras, when viewing colored scenes, to a point where the knee of one tube is not reached earlier than the knee of the others. If this does not occur, the color suffers a strong shift in hue toward the weaker primaries, which also desaturates the picture.

A YRGB camera can use an image-orthicon to generate the luminance signal and tubes of the photo conductive type for the chrominance. The knee of the image-orthicon provides all the necessary protection against the excessive luminance produced by glint and specular reflection. The output of the photo conductive tubes can be limited, if it is desired to desaturate overly bright colors.

Cameras which use newer types of photo conductive tubes, having a linear gamma characteristic, to generate the luminance signal can frequently produce a bright trail when the camera is panned on scenes having strong glint and specular reflections. This is because the absence of a knee causes them to run out of beam current when the brightness is excessive, with

the result that the electrical charges on the surface are not completely discharged.

Moreover, such photo conductive tubes have a relatively narrow spectral bandwidth, and do not reproduce luminance as well as the image orthicon.

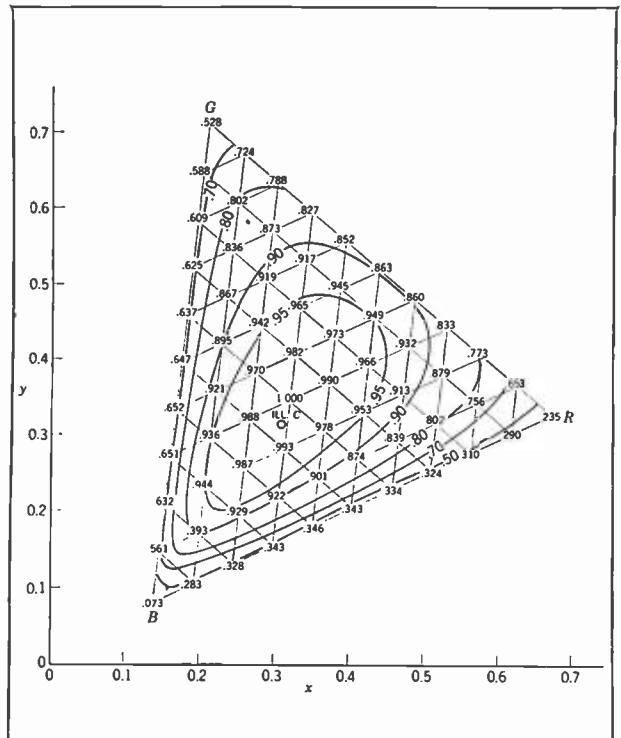

FIG. 5. Chart showing ratio $(Y')/Y$ of the luminance produced by the RGB camera $(Y')/Y = rR^{1/\gamma} + gG^{1/\gamma} + bB^{1/\gamma}$ to the correct luminance $(Y^{1/\gamma})^\gamma = Y$.

VIII. Smaller Chrominance Tubes

The bandwidth of the chrominance signal specified by the FCC is 1.5 mcs. for the I component and 0.5 mcs. for the Q component. However, current commercial receivers do not use more than 0.5 mcs. for both components. Even with the FCC requirement, the RGB tubes of the YRGB camera are called upon to supply much less bandwidth than those of an RGB camera which must generate the luminance signal as well.

The smaller bandwidth required by the chrominance signal means that it can be generated by small tubes of the vidicon-type. Small tubes in turn allow a given amount of light to lay down a higher density of surface illumination. The "lag" of the vidicon decreases with increasing density of surface illumination so that the lag of the camera can be made negligibly small, by maintaining adequate surface illumination.

In addition, small tubes simplify the job of providing scanning uniformity.

IX. Luminance Reproduction

Because the luminance pick-up tube of the YRGB camera picks up the complete luminance information without separating it into its red, green, and blue components, it cannot gamma-correct these components individually. For this reason, it generates a gamma-corrected luminance signal which differs from that produced by the RGB camera. The respective luminance signals are:

- a. From the YRGB camera: $Y^{1/\gamma} = [rR + gG + bB]^{1/\gamma}$
- b. From the RGB camera: $Y' = rR^{1/\gamma} + gG^{1/\gamma} + bB^{1/\gamma}$

The YRGB camera's luminance signal ($Y^{1/\gamma}$) carries the correct luminance for all colors. The RGB camera's luminance signal is correct only on gray scenes and is increasingly in error as the saturation increases.

A. Luminance Reproduction on Monochrome Receivers

The RGB camera generates luminance and chrominance signals which together produce correct colors at correct luminance on color receivers. However, its luminance signal (Y') by itself carries the correct luminance only when shades of gray are in front of the camera. For that reason, the RGB camera does not produce the relative brightness of color scenes correctly on monochrome receivers. For example, the brightness of the red, green, and blue primaries are reproduced by the RGB camera on monochrome receivers at only 23.5%, 52.8%, and 7.30% of their correct respective values. The contrast of color scenes viewed on a monochrome receiver is thereby reduced (see Fig. 5 for the luminance of other colors).

This effect is illustrated in Fig. 6A which consists of two half-fields. The top field is a red Wratten No. 25 filter which, when illuminated by Ill. A, has the following characteristics:

$$\lambda = 615.3 \mu, x = 0.685, y = 0.315, \text{Purity} = 100\% \\ \text{Transmission} = 0.225$$

The bottom field has a neutral density of 1.3 which results in a transmission of 0.05. Since the Y' signal transmits the luminance of the above red at 0.235 of its correct value, the luminance of red reproduced on a monochrome receiver is $0.225 \times 0.235 = 0.05$. Therefore, there is no contrast between the red and gray half fields on a monochrome receiver (see Fig. 6B).

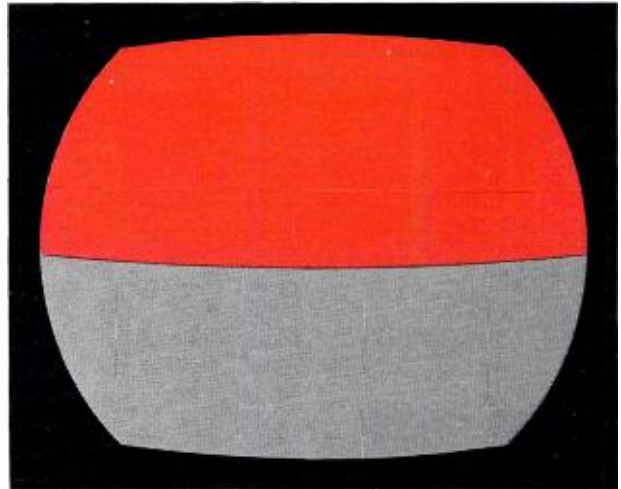

FIG. 6A. Two half-fields of color slide, using Wratten 25 (top) and ND = 1.3, transmission = 0.05 (bottom).

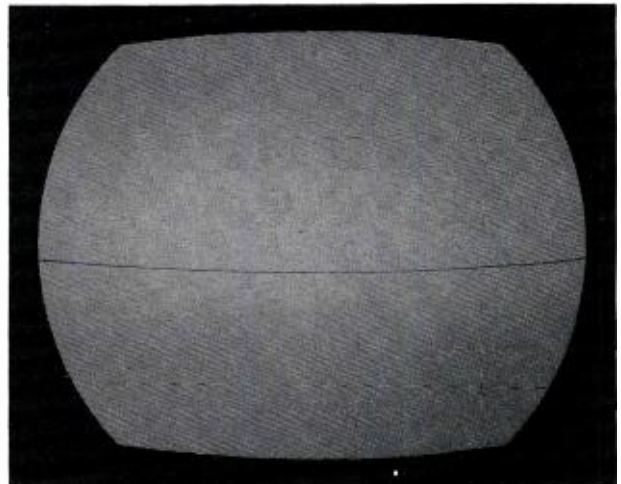

FIG. 6B. Color slide of FIG. 6A as seen on monochrome receiver when produced by RGB camera.

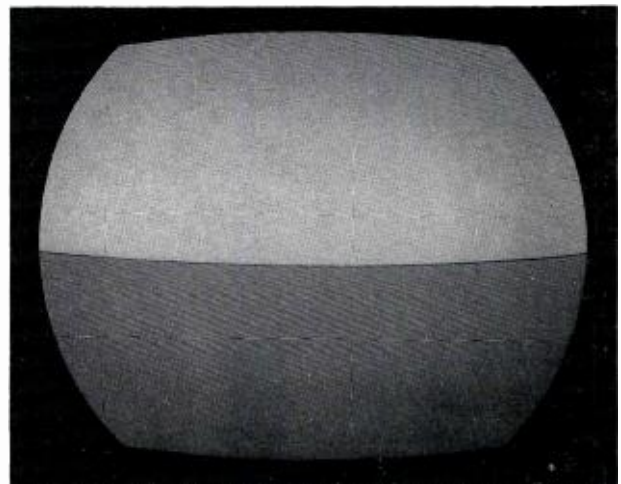

FIG. 6C. Color slide of FIG. 6A as seen on monochrome receiver when produced by YRGB camera.

This deficiency can produce startling effects. For example, let red letters be printed against a darker gray background. If the luminance of the background is 23.5% of that of the red letters, the reproduced monochrome picture shows no contrast and the letters disappear because the letters and background are equally bright. For higher values of red luminance, the letters appear but with reduced contrast when compared with the original.

Figure 7B is an example of the consequences of transmitting color pictures with an incorrect luminance signal as this may cause the word "Never" to disappear on monochrome receivers. For this reason, it is desirable to monitor color transmission on monochrome as well as color receivers.

The same effect can occur in a color receiver when the detail is too fine to pass through its chrominance circuits.

The luminance signal of the YRGB camera carries the correct luminance information for all colors. For that reason, it produces pictures having correct contrast in monochrome receivers. Figure 6A is correctly reproduced in luminance by the YRGB camera on a monochrome receiver as shown in Fig. 6C.

B. Color Receivers

In color receivers, signals from the YRGB camera reproduce some colors with a luminance which is slightly higher than the correct values. For colors having an excitation-purity of 75% or less, the ratio of reproduced luminance to correct luminance varies from 1.0 to 1.4 except for magentas where it may reach 1.90.

The eye is quite tolerant of these errors because, according to the Weber-Fechner law, "sensation varies as the logarithm of the stimulus" so that the errors are compressed. This law applies quite well to stimuli which depend on energy such as luminance. It is not believed to apply to chromaticity.

X. Color Fidelity

The colorimetric reproduction of the RGB camera can be exact if the pick-up tubes track perfectly, if they are gamma-

TABLE I

	Gamma-Correction		Gamma of Picture Tube γ_3	Amplitude of Chrominance Relative to Luminance Signal K
	Luminance γ_1	Chrominance γ_2		
Fig. 8A	2.2	2.2	2.2	1.05
Fig. 8B	2.2	1.5	2.2	0.77
Fig. 8C	1.5	2.2	2.2	1.05
Fig. 8D	1.5	1.5	2.2	0.74
Fig. 8E	2.8	2.2	2.2	1.10
Fig. 8F	2.2	1.5	2.2	1.00

corrected to the gamma of the picture tube, and if account is taken of the negative lobes of the "spectral taking characteristics." Negative lobes introduce noise in the camera output because one signal is subtracted from another but the net noise remains the same. For that reason, negative lobes are usually omitted. This omission causes errors in chromaticity which range from "noticeable" for colors of moderate chromaticity to "very large" for the primaries. (See Table II "Just Perceptible Color Differences" page 39.)

Because they are generated by independent means, the luminance and chrominance signals of the YRGB camera can have different gamma-corrections. This independence provides freedom to gamma-correct for the special conditions described in Section XII and still preserve chromaticity fidelity.

The chromaticity fidelity of the YRGB camera, relative to that of the RGB camera is shown in the CIE chromaticity diagrams on Figs. 8A, 8B, 8C, 8D, and 8E, for the different combinations of gamma-correction and the chrominance gain given in Table I.

FIG. 7. Here (7A) word NEVER is in red. When picked up by RGB camera, and reproduced on monochrome receiver (7B) luminance of word may be depressed to that of background.

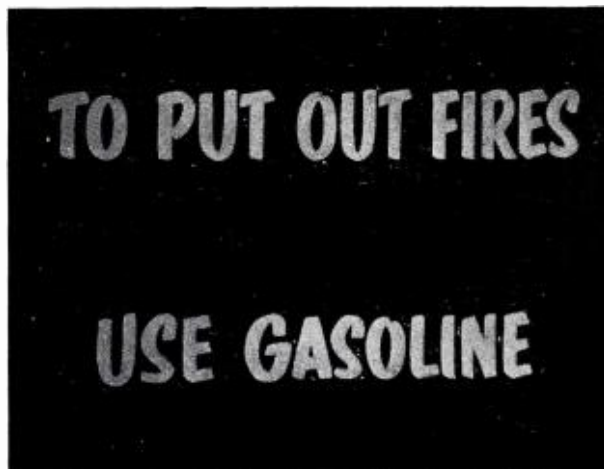
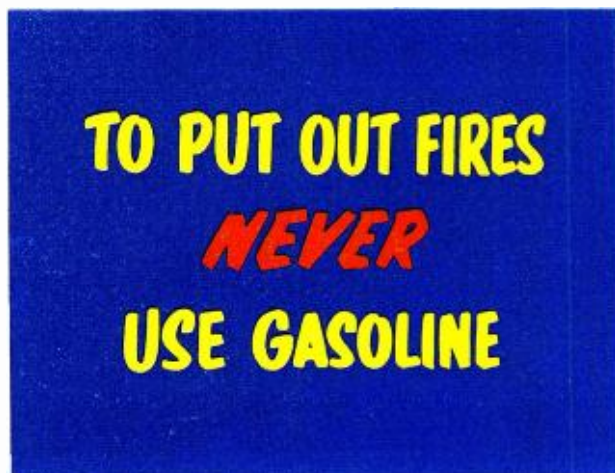

The color theoretically reproduced from a correctly gamma-corrected RGB camera is shown as the tail of an arrow. The shift in chromaticity introduced by the YRGB camera, is shown as the arrow head. The perceptibility of the chromaticity shift in the quantity of "Just Perceptible Color Differences" (JPCD) is given by the number adjacent to the line when the shift is greater than 2.5 units (trace). The perceptibility of JPCD's is given by Hunter for textiles as follows:

TABLE II

JPCD	Perceptibility
0 - 2.5	Trace
2.5- 7.5	Slight
7.5-15.0	Noticeable
15.0-30.0	Appreciable
30.0-60.0	Large
>60.0	Very Large

The saturation can be altered at will by adjusting the chrominance gain (K in Figs. 8A, B, etc.) or by adjusting the chroma control of the receiver. For example, raising K from 0.77 (Fig. 8B) to 1.00 results in the large increase in saturation shown in Fig. 8F. Decreasing K below 0.77 would have the opposite effect. Therefore, the chromaticity difference between the YRGB camera and the RGB camera is negligible.

XI. Gamma-Correction

The independence of the luminance and chrominance channels in the YRGB camera permits them to be separately gamma-corrected to achieve optimum results. Figs. 8A to 8E show that colorimetric fidelity can be achieved with many combinations of gamma-correction.

The luminance noise produced by the camera chrominance channel is negligible so that consideration of gamma-correction for the chrominance channel depends on other factors. One of these is that some vidicons emit a signal which is inherently gamma-corrected to a value of about $1/1.5 = 0.7$, and may not require additional correction.

To minimize the visibility of noise produced by receivers in fringe areas, the luminance signal should be gamma-corrected to the gamma of the picture tube or to a higher value (Figs. 8A, B, E). To minimize camera-noise, the gamma-correction should be less than the gamma of the picture tube (Figs. 8C, D). To compress scenes having a higher contrast than the picture tube can reproduce, the gamma-correction can be made to a value of gamma which is greater than that of the picture tube (Fig. 8E).

Figs. 8A, 8B, 8C, 8D, and 8E shows that the YRGB camera can operate under these several conditions with essentially the same chromaticity fidelity as the RGB camera.

XII. Signal-to-Noise Ratio

The signal-to-noise ratio is approximately that of a good monochrome camera, using the same pick-up tube, and having the same spectral sensitivity.

XIII. Conclusions

The YRGB camera, when compared to the RGB camera:

1. Is more tolerant of registration errors from all causes. When viewed on a monochrome receiver, it is essentially immune to them.
2. Can handle color scenes having more brightness contrast.
3. Provides the correct relative luminance of all colors when its pictures are reproduced on a monochrome receiver.
4. Provides better relative contrast and resolution from all colors when viewed on monochrome receivers than is provided even by a perfectly registered RGB camera. This is because the YRGB camera supplies a luminance signal which is correct for all colors. This is also true for color receivers for detail which is too fine to be passed by the chrominance circuits.
5. Provides a chromaticity which differs negligibly from that of the RGB camera.
6. Reproduces some colors with somewhat greater luminance than is present in the original.
7. Can be more easily adapted to values of gamma which satisfy special conditions and still maintain chromaticity fidelity.
8. Has a signal-to-noise ratio approximately equal to that of a good monochrome camera, using the same pick-up tube, and having the same spectral sensitivity.

Note 1—See pages 40-45 for Figures 8A-8F inclusive.

Note 2—See pages 46-47 for Appendices A and B.

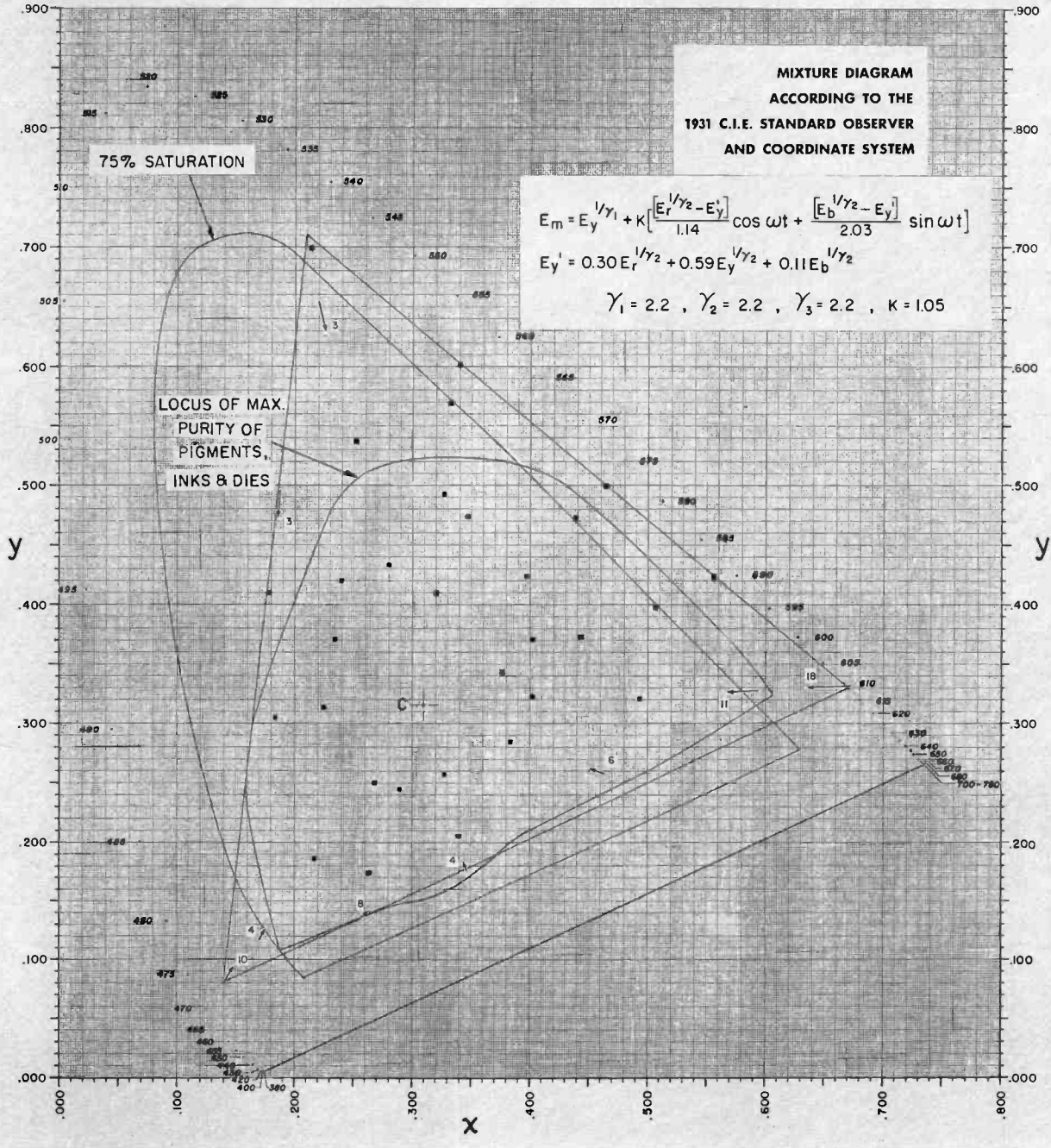

FIG. 8A. Shift in chromaticity reproduced by color receiver when the luminance signal is $E_y^{1/\gamma}$, instead of E_y' , for the values of $\gamma_1, \gamma_2, \gamma_3$ and K given above. The chromaticity reproduced by standard conditions ($E_y', \gamma_1 = \gamma_2 = \gamma_3 = 2.2, K = 1.0$) is shown by a dot. The amount of shift is indicated by a line extending from the dot. The number adjacent to the line indicates the quantity of "Just Perceptible Color Differences" when their perceptibility exceeds a "trace" (>2.5). See Appendix B.

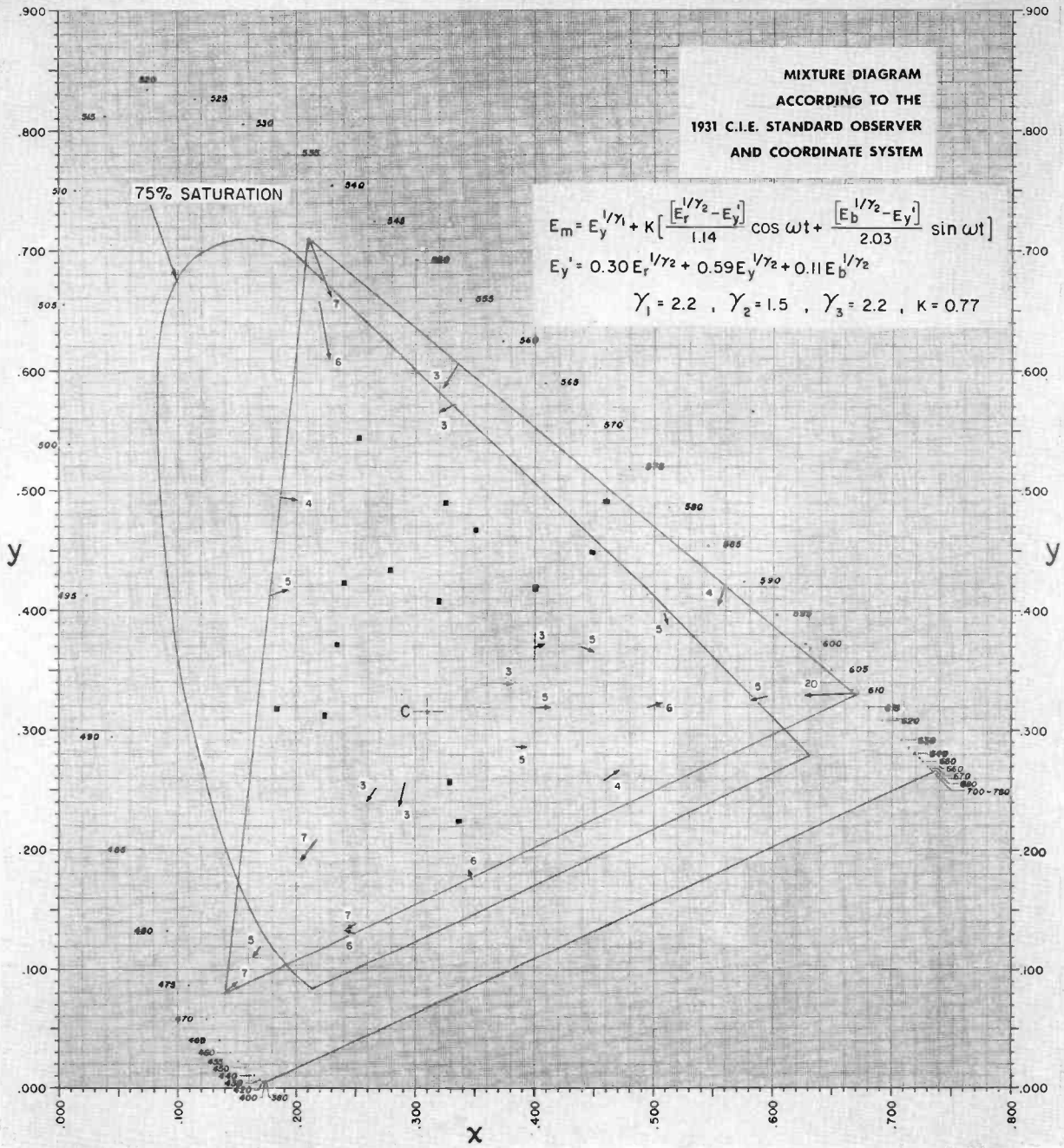

FIG. 8B. Same as FIG. 8A, except for values of γ_1 , γ_2 and K .

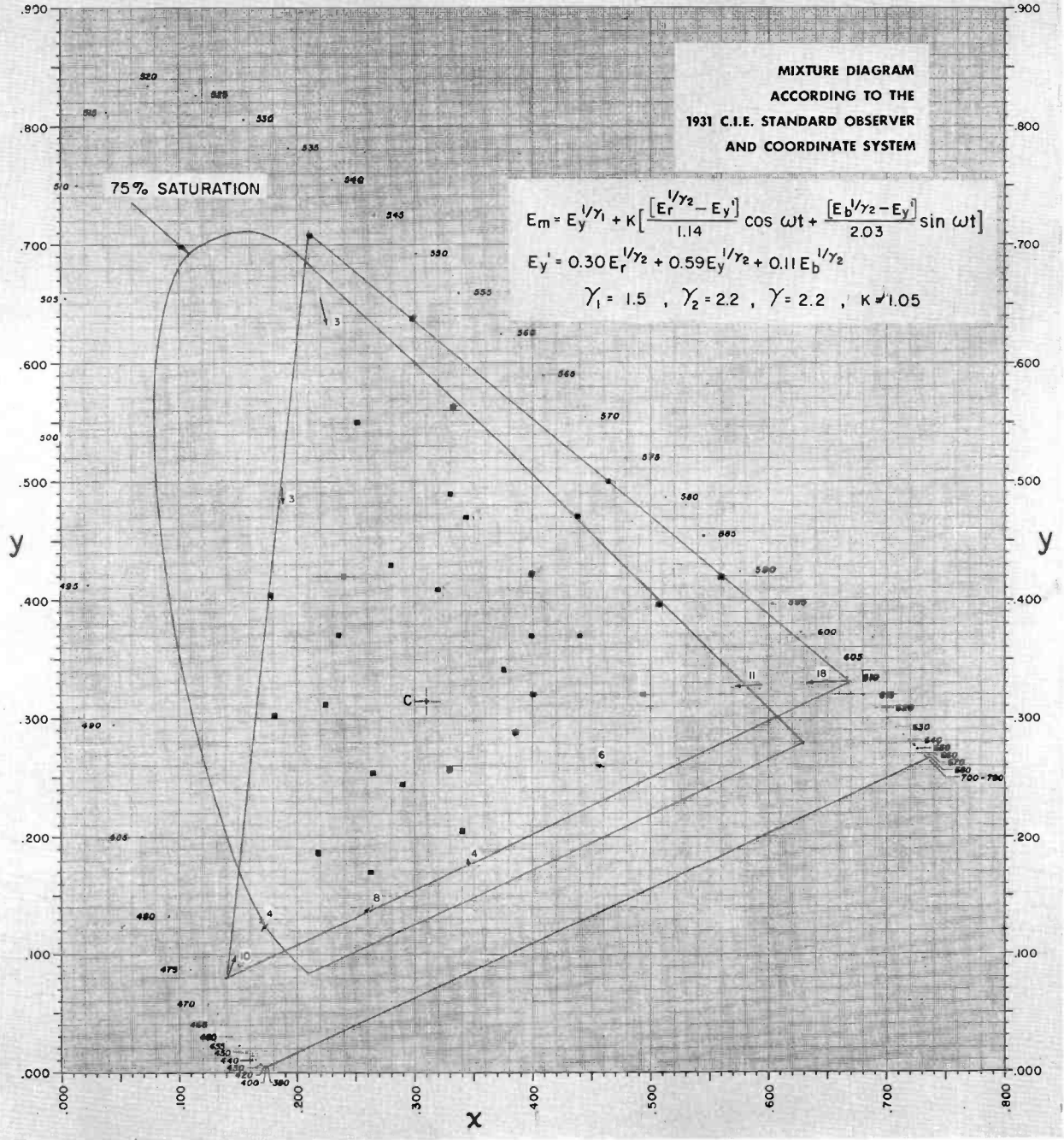

FIG. 8C. Same as FIG. 8A except for values of γ_1, γ_2 and K given above.

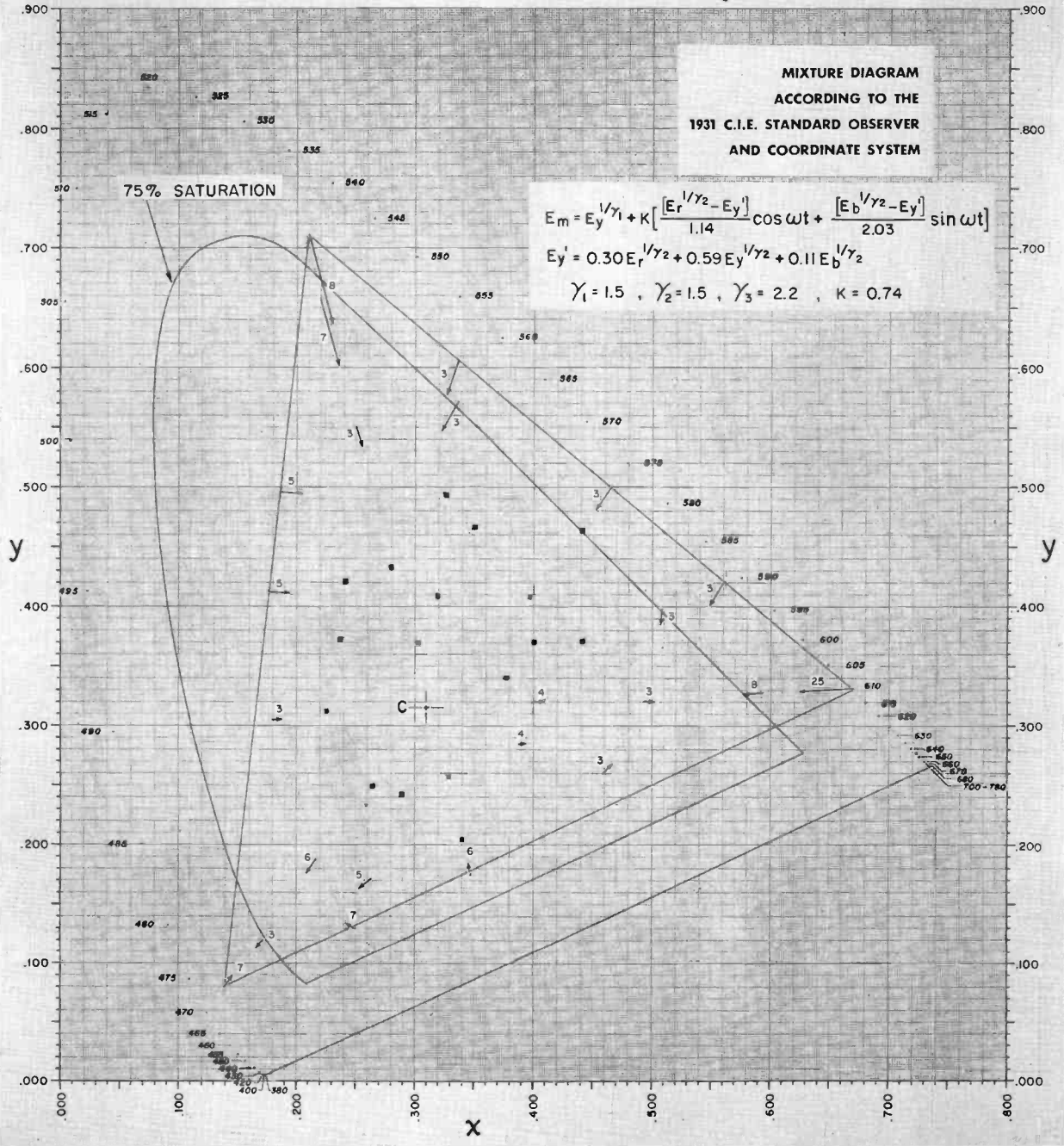

FIG. 8D. Same as FIG. 8A except for values of γ_1 , γ_2 and K given above.

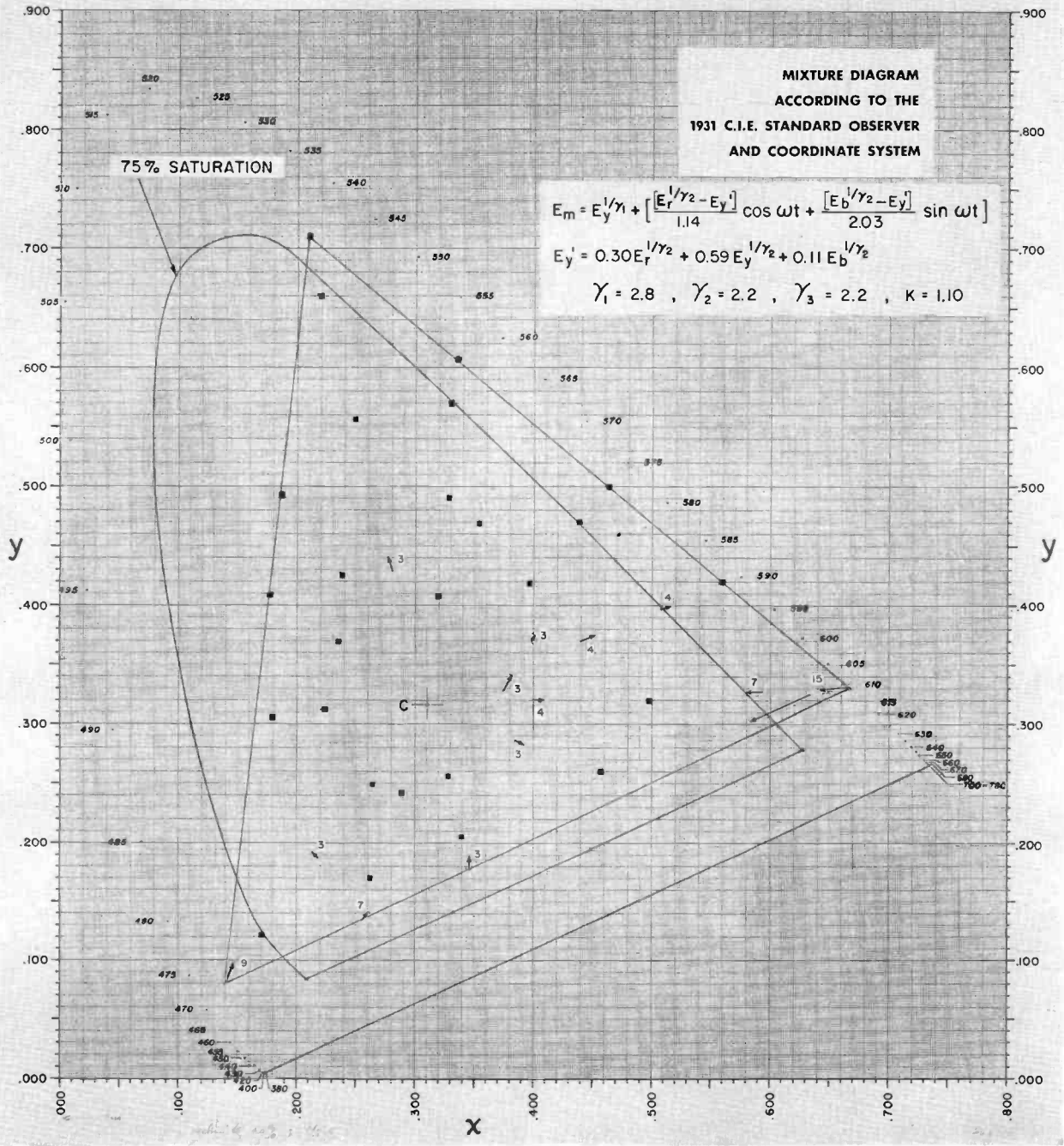

FIG. 8E. Same as FIG. 8A except for a values of γ_1 , γ_2 and K given above.

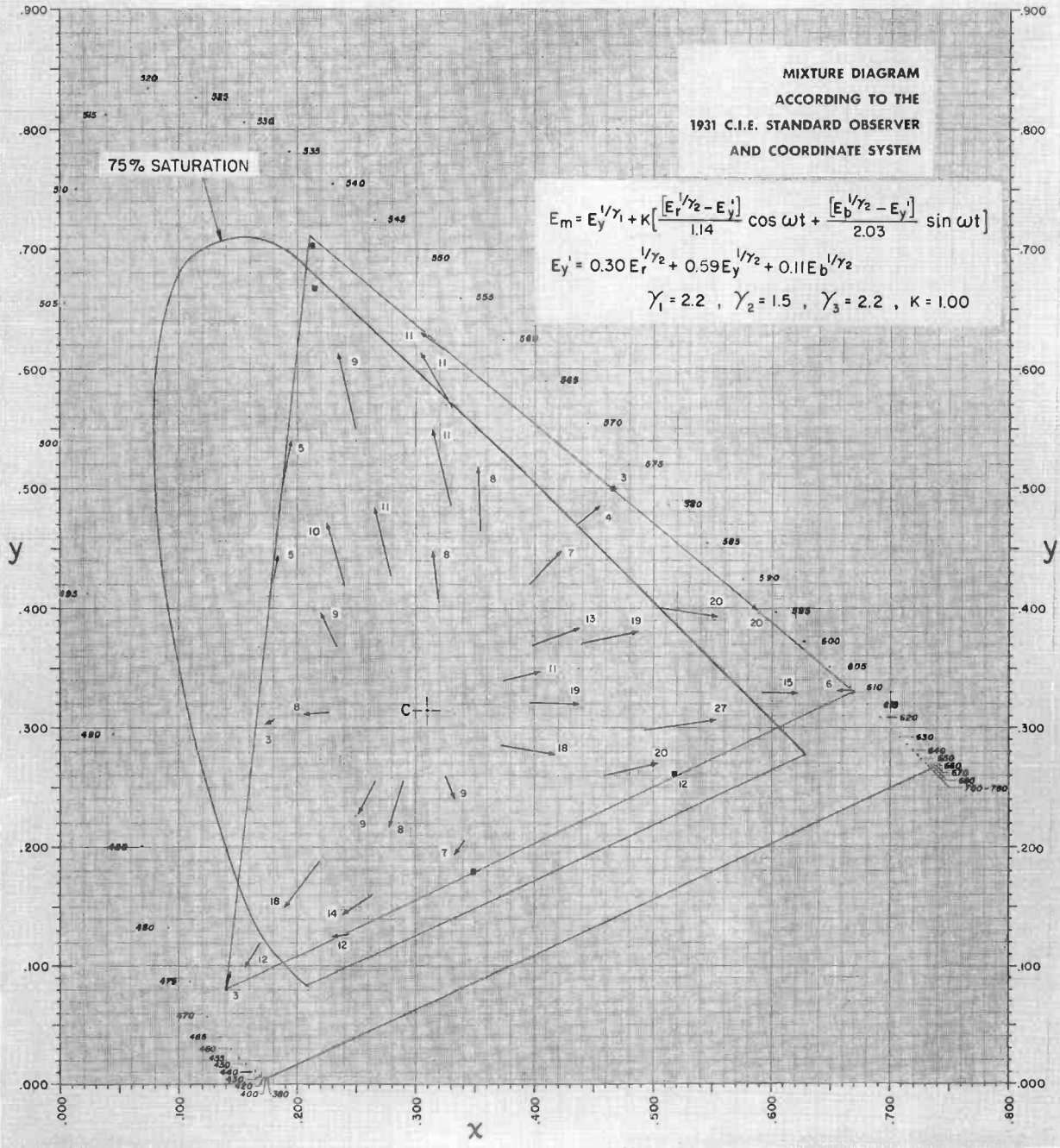

FIG. 8F. Same as FIG. 8A except that $K = 1.00$.

Appendix A

Colorimetry of the YRGB Camera

To avoid the question of the minor lobes of the spectral taking characteristic of color cameras, the calculations of color shifts introduced by the YRGB camera are referred to the reproduction of colors already on the picture tube. The steps in the calculations are:

1. A color on the picture tube is defined by Y, x, y .
2. The corresponding tristimulus values (R, G, B) are calculated from:

$$R = Y \{ 1 + p_r (x/y - x_w/y_w) + q_r (z/y - z_w/y_w) \} \quad (A-1)$$

$$G = Y \{ 1 + p_g (x/y - x_w/y_w) + q_g (z/y - z_w/y_w) \} \quad (A-2)$$

$$B = Y \{ 1 + p_b (x/y - x_w/y_w) + q_b (z/y - z_w/y_w) \} \quad (A-3)$$

3. The quasi-luminance Y' is then calculated from:

$$Y' = s_r R^{1/\gamma_2} + s_g G^{1/\gamma_2} + s_b B^{1/\gamma_2} \quad (A-4)$$

where the coefficients p, q , and s , with their subscripts, are functions of the chromaticities of the primaries and of reference-white; and where x_w, y_w, z_w are the CIE coordinates of reference-white. Numerical values of these coefficients and coordinates are given below for the NTSC primaries centered on Illuminant C. See the references for coefficients based on other parameters.

4. The signals from the RGB camera are assumed to be proportional to Y' and to

$$R' = R^{1/\gamma_2}, G' = G^{1/\gamma_2}, B' = B^{1/\gamma_2}$$

where γ_2 is the value of γ to which the signals are corrected.

5. The color-difference signals received by the receiver are then proportional to:

$$R^{1/\gamma_2} - Y'; G^{1/\gamma_2} - Y'; B^{1/\gamma_2} - Y' \text{ (as in the RGB camera)}$$

6. When the receiver picks up signals from the YRGB camera, the luminance signal is Y^{1/γ_1} instead of Y' , so that the signals presented to the three guns of the picture are respectively:

$$\left(R^{1/\gamma_2} - Y' + kY^{1/\gamma_1} \right), \left(G^{1/\gamma_2} - Y' + kY^{1/\gamma_1} \right), \left(B^{1/\gamma_2} - Y' + kY^{1/\gamma_1} \right),$$

7. The three guns of the picture tube use these signals to produce the following three new tristimulus values:

$$R'' = \left(R^{1/\gamma_2} - Y' + kY^{1/\gamma_1} \right)^{\gamma_3} \quad (A-4a)$$

$$G'' = \left(G^{1/\gamma_2} - Y' + kY^{1/\gamma_1} \right)^{\gamma_3} \quad (A-4b)$$

$$B'' = \left(B^{1/\gamma_2} - Y' + kY^{1/\gamma_1} \right)^{\gamma_3} \quad (A-4c)$$

where: R'', G'', B'' are the tristimulus values which differ for R, G, B because the luminance signal Y^{1/γ_1} has been substituted for Y' ; γ_1 is the value of gamma correction of the luminance signal which, for flexibility, need not be equal to γ_2 the value to which the color-difference signals are corrected. γ_3 is the gamma of the picture tube. k is a design constant whose purpose is to adjust the value of saturation.

8. The values of R'', G'', B'' are then substituted in equations A-1, A-2, A-3 to calculate the corresponding values of:

$$x' = x + \Delta x, y' = y + \Delta y, z' = z + \Delta z, Y'' = Y + \Delta Y \quad (A-5)$$

Y'' can also be calculated independently from

$$Y = s_r R + s_g G + s_b B \quad (A-6)$$

also, one should remember that:

$$x + y + z = x' + y' + z' = s_r + s_g + s_b = 1.0$$

A computer program was then established in which the independent variables Y, x, y were introduced and the dependent values of Y'', x', y' were computed. These values are used to plot the arrows showing the shift in chromaticity on the CIE diagrams; (x, y) are the coordinates of the tail of the arrows, (x', y') are the coordinates of the head of the arrows. The visibility of these changes is given in JPCD/5 as shown in Appendix B.

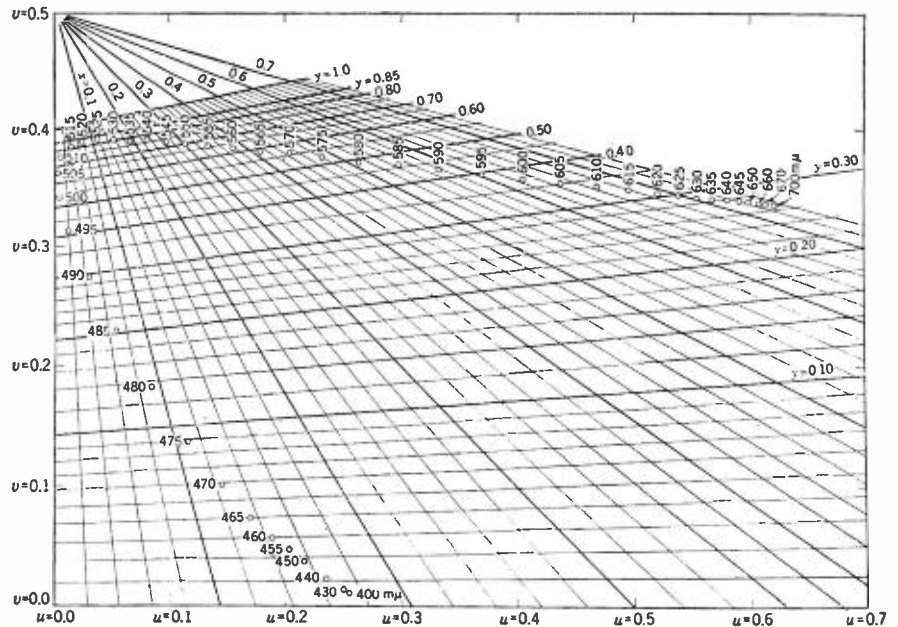

FIG. B1. Uniform Chromaticity Scale Diagram.

The coordinates of the NTSC primaries and Illuminant C are:

	r	g	b	Ill.C
x	0.670	0.210	0.140	0.310
y	0.330	0.710	0.080	0.316

The values of the coefficients p, q, and s are:

p	1.910	-0.985	0.058
q	-0.288	-0.028	0.897
s	0.30	0.59	0.11

For values of p, q, and s corresponding to other primaries, the reader is referred to the following references:

(A-1) F. J. Bingley—"Colorimetry in Color Television"; Proc. IRE Vol. 42 No. 1, Jan. 1954.

(A-2) C. J. Hirsch—"A Study of the Need for Color Controls on Color TV Receivers in a Color System Operating Perfectly." IEEE Transactions on Broadcast and Television Receivers, Nov. 1964.

Appendix B

Perceptibility of Color Differences

The CIE diagram does not give an appreciation of the perceptibility of color differences. The Uniform Chromaticity Scale Diagram (UCS) is a transformation from the CIE diagram. On the UCS diagram, perceptibility of color differences is approximately proportional to distance. The transformation is as follows:

$$u = f(x,y) = (0.4661x + 0.1593y) / (y - 0.15735x + 0.2424) \quad (B-1)$$

$$v = g(x,y) = (0.6581y) / (y - 0.15735x + 0.2424) \quad (B-2)$$

then $u' = f(x', y')$; $v' = g(x', y')$

the distance (d) on the UCS diagram is then

$$d = \sqrt{(u - u')^2 + (v - v')^2} \quad (B-3)$$

The calibration of this distance to (N) the number of "Just Perceptible Color Differences" (JPCD) was obtained as follows:

MacAdams diagram of "Approximate Perceptibility of Chromaticity Differences" Fig. B2 shows 100 JPCD's between $\lambda_d = 0.564\mu$ and $\lambda_d = 0.570\mu$. This quantity was then used to calibrate the distances on the UCS diagrams to:

$$N = 2000 \sqrt{(u - u')^2 + (v - v')^2} \text{ JPCD's} \quad (B-4)$$

The number of N of "Just Perceptible Color Differences" (JPCD) given by the above formula is divided by 5, according to a recommendation by D. B. Judd, because the perceptibility of color differences is less for the small areas of different colors of television than for the larger fields for which N is usually derived.

N/5 is then evaluated subjectively according to a "Textile Subjective Scale" suggested by Hunter, as follows:

TABLE IIA

N/5	Perceptibility
0 — 2.5	Trace
2.5 — 7.5	Slight
7.5 — 15.0	Noticeable
15.0 — 30.0	Appreciable
30.0 — 60.0	Large
> 60.0	Very Large

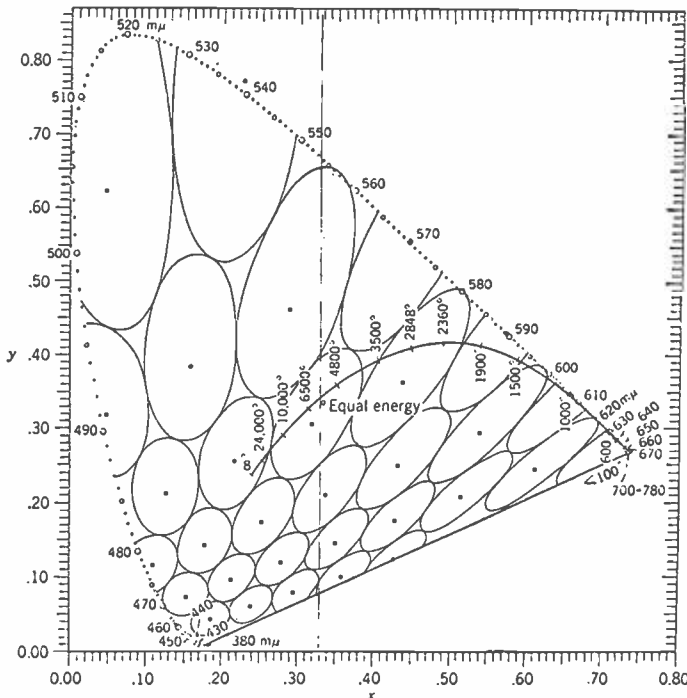

FIG. B2. McAdams Ellipses showing Approximate Perceptibility of Chromaticity Differences in the xy chromaticity diagram. Each closed curve shows 100 times the JPCD under moderately good viewing conditions.



FIG. 1. The WCEE-TV Master Control was planned with switcher, video and cartridge tape machines, film and slide projectors, and camera control units for TK-60 and TK-41 cameras, all located in one room. Since this area is adjacent to the transmitter on the left, it is possible to operate with

only one engineer and one film man. Left to right are Engineer, Dick Edwards; Chief Engineer, Don Dougherty; Engineer, Bob DeMeester; and Film Director, Jim Hague. All cables are run in trays mounted to the lower level ceiling giving a much cleaner look in the Master Control area.

SUCCESS IN UHF

WCEE-TV Planned for Efficiency, Designed for Compactness and Organized for Service

by EARL W. HICKERSON

*Vice President and General Manager
Rock River Television Corp., Rockford, Ill.*

History

WCEE-TV is the newest television station serving Northern Illinois and Southern Wisconsin with 674,000 watts of power from Rockford, Illinois, on Channel 23. The air date was September 12, 1965, as a primary affiliate of CBS.

The station is owned by the Rock River Television Corp., which is composed of a number of area businessmen, investors and advertisers.

The Corporation was organized to bring full network service to the nation's 94th market and to the second largest city in the state of Illinois, to make available greater community service through a

powerful and effective medium and also as a financial investment.

Station Philosophy

The plan was to build a station as modern as possible, to take advantage of the experience of the past 15 years, and to use the electronic advances for a modern, efficient and effective operation.

The major problem for this station, or any new television operation for that matter, was to be able to offer to viewers and advertisers something that would "woo" sufficient numbers to make a profitable operation.

Rather than ease into competition, it was planned to use the approach of posi-

tive competition for audience and sales—by utilizing promotional, operational, sales, production and engineering facilities that demonstrate experience, creativity and know-how. We put this plan in action in our initial decision for the purchase of equipment and design of the building.

The line of RCA equipment was purchased on the basis of all-transistorization for better performance, stability and maintenance, and WCEE-TV became one of the first commercial stations in the country to install this new line from transmitter to video tape to studio cameras.

Layout Efficiency

In laying out the building plans, com-



FIG. 2. The first floor houses the offices, studio and transmitter. Note the proximity of sales, programming, continuity, art and photo for the production planning.

FIG. 3. Operator Dick Clay at the console in master control handles the station breaks while at the same time is able to watch the operation of the transmitter.

pactness in size, functional and efficient service were the objectives.

A single structure of 13,000 square feet to house the offices, studio and transmitter was approved. The basement houses accounting, news, public affairs, promotion department, lounge and part of the transmitter heat exchanger.

The sales, program and production planning offices are located as one unit in the entry area so that constant attention can be given to the creative people (continuity, photo, artist) as commercials are developed for strongest visual and aural impact.

The production manager is located in the same office as the continuity writers



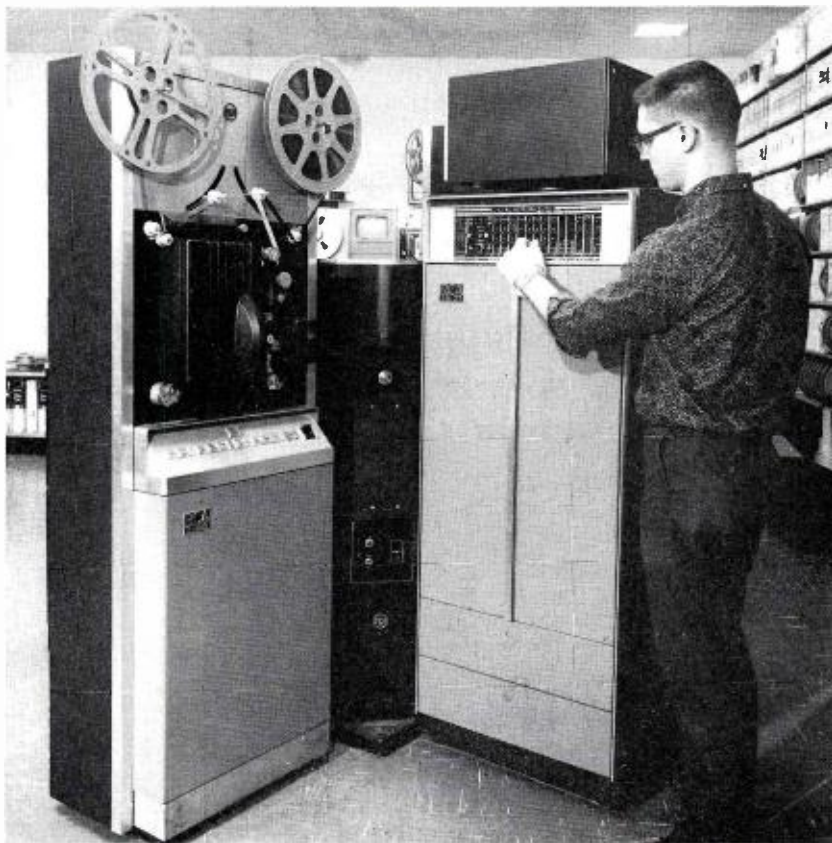

FIG. 4. Film Editor, Larry Neuzel inspects solid-state, plug-in module bank of the RCA TK-27 color film camera. Use of the magnetic stop on the RCA TP-66 projector (left) frees the projectionist for other chores after loading the slide and film projectors and checking the equipment.

and they work closely on what is written, how it can be produced, and the planning of live and video tape sessions.

Quality Control

All broadcasters know that planning is important, but, in reality, the facility itself, and the desire and ability of the engineer and production departments determine, in most cases, "the look" of the station on the air. Therefore, this key area has been tabbed "Quality Control."

Master Control was planned with switcher, video tape and cartridge tape machines, film and slide projectors all located in one room. This is adjacent to the transmitter so that only one engineer and one film man are needed to operate cleanly, sharply and efficiently from sign-on to sign-off, seven days a week.

We free our announcers from booth shifts by pre-recording all their material on cartridge tape, then using the electronic

trip. As a result, slide changes are cleaner on the air, and it does away with possible human mistakes when calling for manual changes.

Originally, the RCA TR-4 recorder and TR-3 playback video tape machines were installed for flexibility in operation. These offered two playback machines for cross-rolling, enabled us to meet on-the-air playbacks even if one machine became in-operative, also meant a smaller investment.

The heavy demand, however, for local advertiser production put such strain on the one recording machine, so that after six months, record components for the TR-3 were ordered — converting it to a two-function TR-4. Color playback modules for the TR-4 were also installed.

Semi-Automatic Operation

With the magnetic stops on the film together with the instant-start feature of the TP-66 projectors, the film men need only

to load the slide and film projectors — but do not have to start, stop, and change as in the past. Freeing them from these chores, gives them time (after checking the equipment) for editing, shipping and other duties.

The RCA TS-40 switcher was split to allow us to use part of it in the master control room and the remainder in the studio control room. The operating engineers find that the one-step preset and touch-bar helps them perform the changes and switches cleaner and more correctly.

Remote start, stop and change buttons were installed in both master control and studio control for greater flexibility of operation.

Duplex Production

Since this is a two-level building, trays to carry the wires rather than floor trenches are used.



FIG. 5. Earl W. Hickerson, vice-president and general manager, came to Rockford, Ill., December, 1964—after the Rock River Television Corporation had received a construction permit for Channel 23. Previously, Mr. Hickerson had worked at KOCO-TV, WFMY-TV, and WTVP. Prior to television, he spent six years in radio.



FIG. 6. Due to heavy demand for local production, the record components for the TR-3 were installed after only six months on the air. The machines are equipped to record and play color video tape. Engineer, Dan Wasmund, checks performance.

Only four feet from the film island is the door to the film editing office, where commercial and public service slides and 16mm film are ordered, received, edited, stored and shipped.

This department prepares and loads film and slides for use, but (as noted above) the projectors are rolled and the slides are changed by the master control engineer or the studio control director.

When studio facilities are required, production personnel handles the audio board and the switcher in the separate studio control room overlooking the 40 by 60 foot studio. This room is also adjacent to the announce booth and is utilized for tape sessions. A video tape engineer is scheduled for more efficient production and to keep from disrupting the master control operations.

Technical Versatility

The cameramen and floor crew are also

production personnel. This unit can rehearse and produce (live or on video tape) programs or announcements without disturbing the important day-to-day operations.

The video controls for the cameras are mounted in the master control board and the operator on duty checks video, but, here again, the newer, more stable equipment does not require constant attention for good results.

In order to continue video tape production while a film presentation is on air (or a station break is being made) the TP-15 multiplexer allows us to split the film operation and have two sources in action from one film island.

Local sponsors have access to rear screen projection, teleprompter equipment, controlled lighting with a modern dimmer control panel, a 60-foot cyclorama, drapes, flats, etc. The studio is designed

to allow automobiles to be driven in for commercials.

Early Planning for Color

From the beginning, we were planning for color. At air date, we were able to telecast network programming, local film and slides in color. Consequently, we took the lead in the use of local color slides and color film production, since the competition did not match our capability until three to six months later.

Studio color facilities were discussed in January, 1965, when the equipment was ordered, but it was decided that since the color explosion had not occurred at that point, we would not start with local live color cameras or color video tape facilities. Instead, we planned the lighting, drapes, monitors and other technical equipment for live color so all we would have to do was add the cameras.

This key step came on October 23, 1966, when we started televising in local color

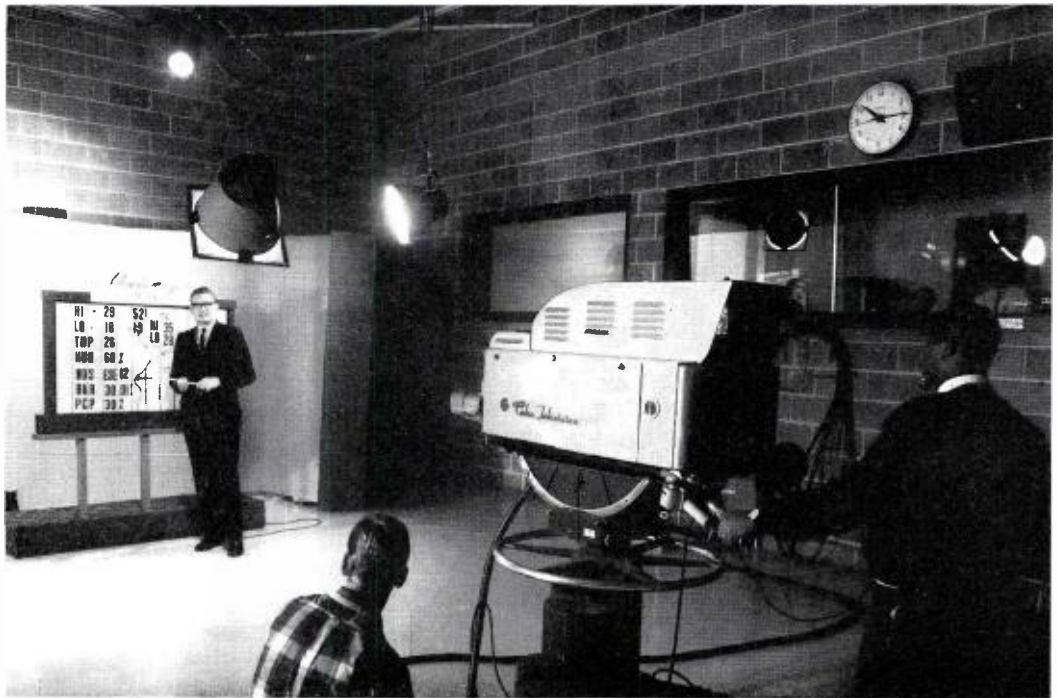

FIG. 7. With the installation of a TK-41 color camera, WCEE-TV became the first station in the area outside of Chicago and Milwaukee to go full color. All scoops and spots have been painted various colors to add to the all color theme. The Tri-King display board is utilized for the weather. Each of the three faces of the board is a different color.

and recording and playing back color video tapes. By going to local color at this time, we became the first station in this area outside of Milwaukee and Chicago to have full color facilities.

Color Inaugural

The color inaugural program involved mayors and Chamber of Commerce representatives from ten of our major cities in the Channel 23 coverage area as well as some national dignitaries.

For this inaugural program, we started with the news in monochrome. Then the newscaster stated that these guests were in our control room poised to jointly push the button to switch us from monochrome to color cameras. After showing our visitors in black and white on a 5-4-3-2-1 count-down, we went to color and all viewers with color sets saw the local news, sports and weather in living tint.

Also taking part and presenting congratulatory messages on film were Senators Dirksen and Douglas of Illinois, and Governor Knowles of Wisconsin. Our station

is located in Northern Illinois, only 18 miles from the southern part of Wisconsin.

Amazing Growth

There is between 15 and 20 percent color set penetration in this area. The large color set total has helped us gain additional viewers and has given us another sales tool to offer sponsors. This has helped gross revenue by both time-sales and video tape production charges.

WCEE-TV went on the air with 20 people on the staff and only about 42 hours a week programming due to limited availability of network for the first 13 weeks. Our staff and programming, however, continued to increase. Now we have about 50 people, we broadcast nearly 120 hours a week, and we have the full CBS network schedule.

Community interest is reflected not only in having a fully-equipped news department but also a public affairs director. His full-time job is working with the Chambers of Commerce, city governments and other groups in our coverage

area in an attempt to find out what the audience wants from their station, then developing these suggestions into television features.

Emphasis on Public Service

To encourage use of our facility by area groups, clubs and organizations, WCEE-TV and the Junior League of Rockford jointly sponsored a Public Service Seminar at the station in October, 1966. Over 175 area representatives came to the studio. There was a morning seminar produced by our staff on how to get more mileage from pet projects on both radio and television. At noon, over 200 attended a Seminar luncheon to hear Commissioner Robert E. Lee of the Federal Communications Commission speak on "Current Trends in Telecommunications."

All guests were invited to send suggestions and comments about our station in helping us to continue formulation of plans for the future.

To give the viewers an opportunity to visit our facility and to focus attention



FIG. 8. Studio Control and the announce booth look directly into the studio. Director, Jon Boettcher, does his own switching during live and tape sessions. The audio man has a BC-8 audio console turntable, cartridges and reel recorders at his fingertips. The booth announcer can look into the studio control room or into the studio.

on the network daytime programming, we held an Open House in January, 1966, for invited guests and the public.

A private cocktail party for 300 was held on a Thursday. Two days later, almost 7500 went through the station in a six hour period. The amazing thing was that the temperature was 10 below zero all day long, and the visitors stood outside, waiting up to 30 minutes, to get inside for the tour. We had closed circuit cameras arranged so each person could see himself on a monitor. There were balloons for the children, promotional material, and a few inexpensive gimmicks for the adults.

Spiralling Success

Sales have been increasing rapidly. The audience growth has been speedy. In 13 months, rating services showed our sign-on to sign-off metro share of the audience going from 10 to 15 to 23 to 25 to 33 percent of the audience.

We are pleased and excited with the growth, acceptance and future of WCEE-TV, Rockford, Illinois.

FIG. 9. Engineer Dick Edwards checks the exciter portion of the TTU-30A transmitter. The heat exchanger and water pumps are located on the lower level directly below the transmitter.

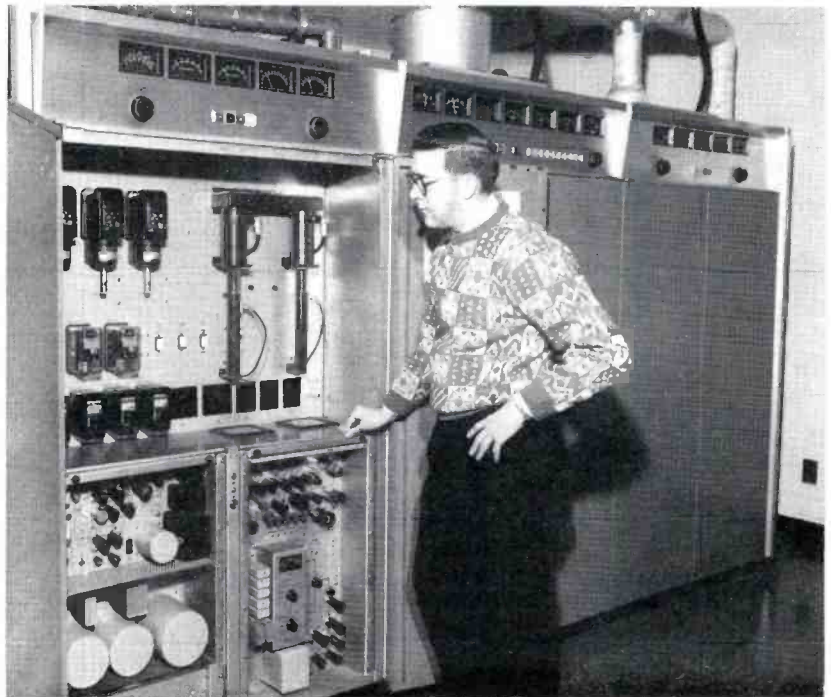

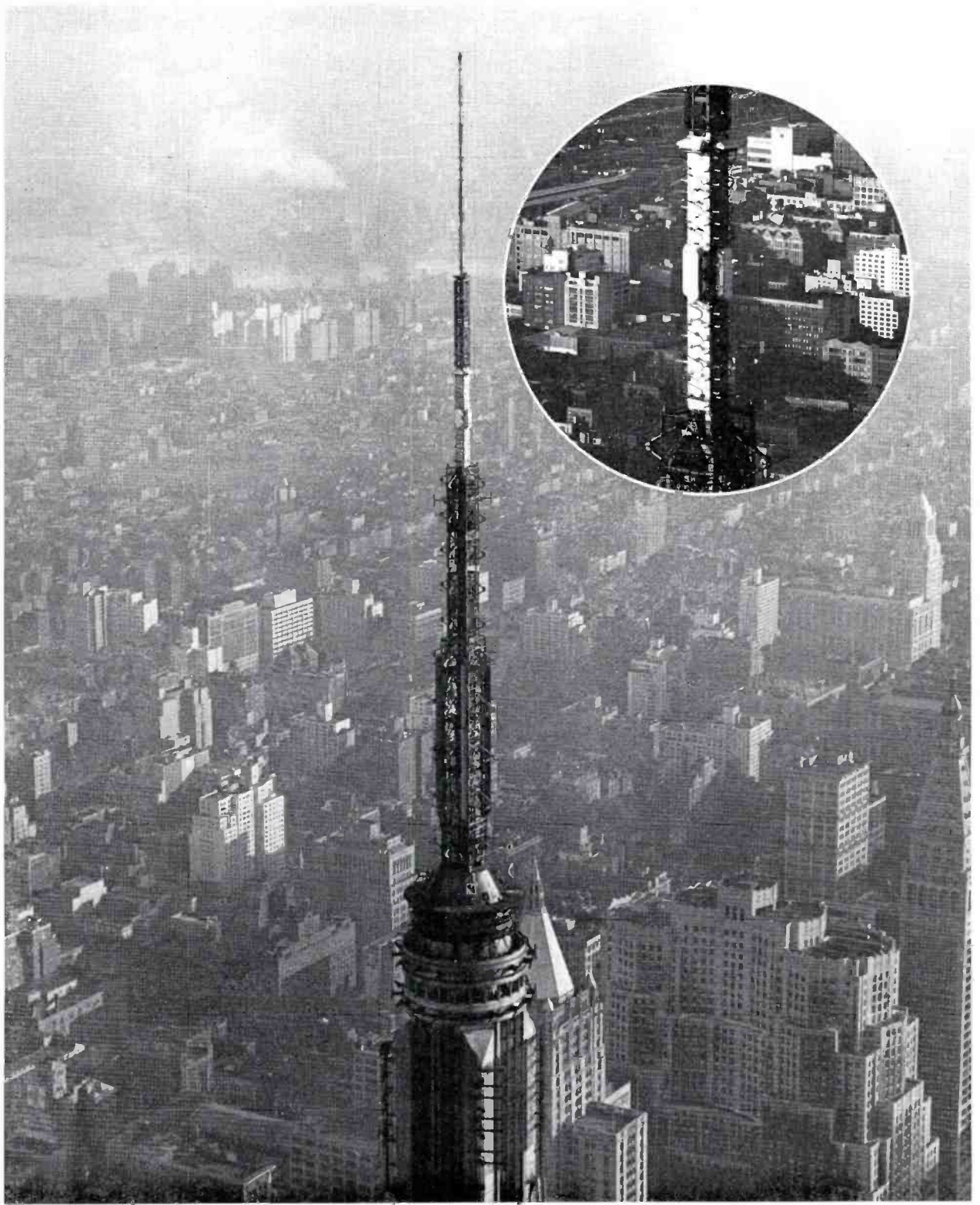

FIG. 1. Helicopter view shows "new look" of multiple antenna structure on Empire State Building, which now includes WABC-TV's gleaming new RCA Zee Panel.

WABC-TV INSTALLS "ZEE PANEL" ANTENNA ON EMPIRE STATE BUILDING

New RCA Development Provides Excellent Horizontal Circularity with Null-Free Vertical Pattern and Power Handling Capacity for Future Needs

by B. K. KELLOM
VHF Antenna Product Analyst

Late last year a custom designed, Channel 7 "Zee Panel" antenna was installed on the Empire State Building for WABC-TV to replace an antenna that had been in use 15 years. The station's decision to update their antenna facilities and thus take advantage of current state-of-the-art performance established certain criteria for the new antenna system: (1) Provide uniform service to the station's market by improving both the horizontal

and vertical pattern characteristics; (2) Provide a power handling capacity of 100 kW peak visual (20% aural); (3) Provide an optimum input impedance characteristic and bandwidth consistent with best picture quality; and (4) Provide maximum year round performance reliability with minimum maintenance.

Stringent Design Requirements

While satisfying these objectives, the

new antenna had to fit into the 25.66 foot space occupied by the former antenna (This requirement eliminated the Traveling Wave antenna which would have been ideal from a performance standpoint.) There had to be access to the interior of the mast to service the transmission lines running to other antennas mounted above. The wind load rating of the antenna was to be 50/33 psf, with stable operation under conditions of extreme icing, snow

FIG. 2. Inspecting the Zee Panel antenna at RCA Antenna Engineering test site are (from left) Mr. Henry Dabrowski, chief engineer of WABC-TV, Mr. Robert M. Morris, staff consultant to the ABC engineering department and Dr. Matti Siukola, RCA, designer of the antenna.

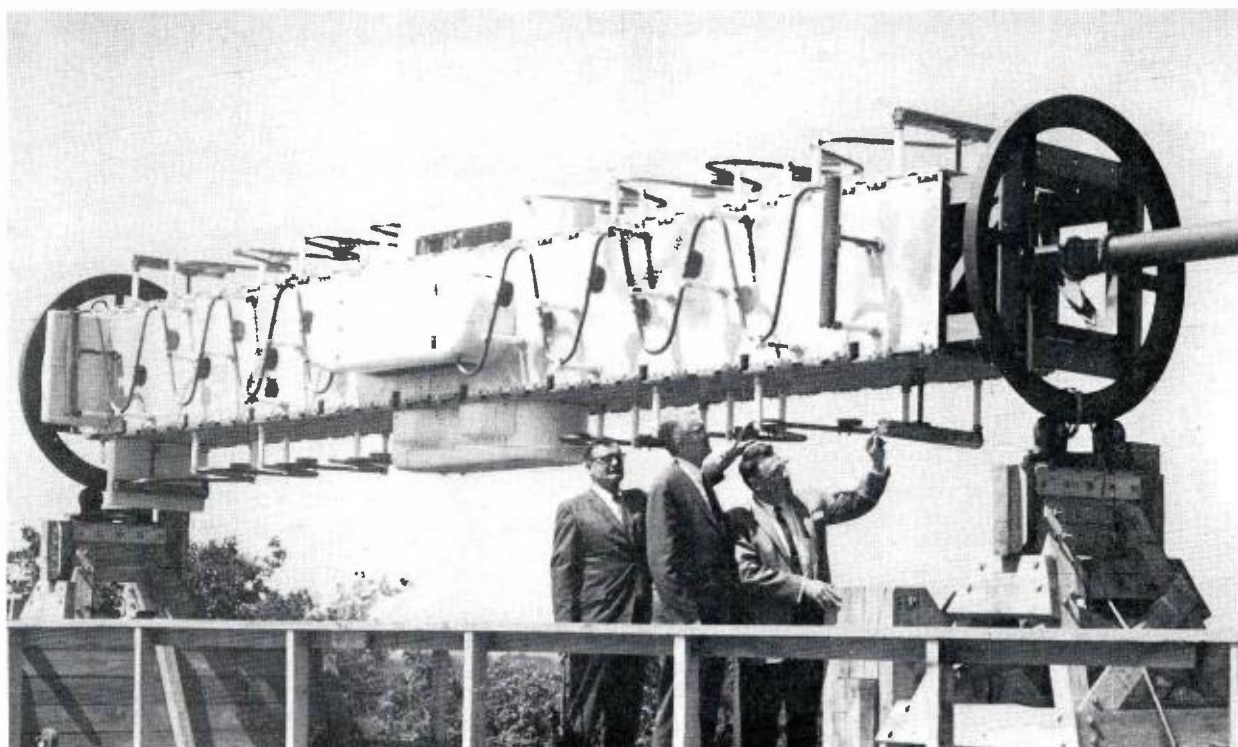

and sleet. Electrical performance called for a power gain not less than 3.8 at visual carrier and a circularity of ± 1.5 dB or better. The vertical pattern requirements were a completely null-filled pattern with a minimum of 10% out to 20 degrees below the horizontal. In addition, there was need for constant monitoring of VSWR at the feed points, and originally, there was specified a beam tilt of 0.7 degrees which was finally not required, as explained later in this article.

Antenna Development

The antenna to meet all these design requirements was a panel type antenna consisting of a zig-zag radiator mounted

against a screen with the panels arranged around the four faces of a square tower.

Basic development of the Zee Panel, as it is called, plus fabrication and pattern tests took place over a period of six months at the RCA antenna engineering and manufacturing facility at Gibbsboro, New Jersey.

The face to face dimension of the supporting tower is such that the horizontal circularity requirement of ± 1.5 dB is easily met. In addition, there is only one $3\frac{1}{8}$ -inch feed point for each face, making a total of four for the entire antenna, thereby contributing greatly to the reliability improvement.



FIG. 3. The Zee Panel mounted high on horses and turntable for radiation pattern measurements. In plotting horizontal circularity patterns, the antenna revolves on the horses. For vertical pattern tests, the entire assembly rotates.

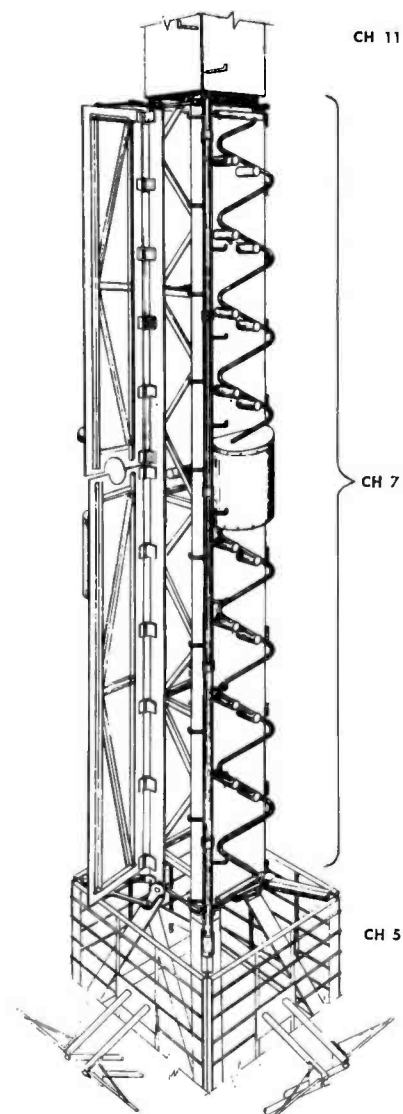

FIG. 4. Artist projection, sketched in early planning stage, shows antenna location above Empire State tower and construction features such as protective radomes in the center and hinged panels for access to transmission line.

Construction Features

The North, South, East and West panels of the square structure each consist of upper and lower sections bolted together at the center around an end seal. The North and South panels are bolted securely to the steel tower, while the East and West panels are hinged along one edge to provide access to the internal feed system. Construction is visible in Fig. 5.

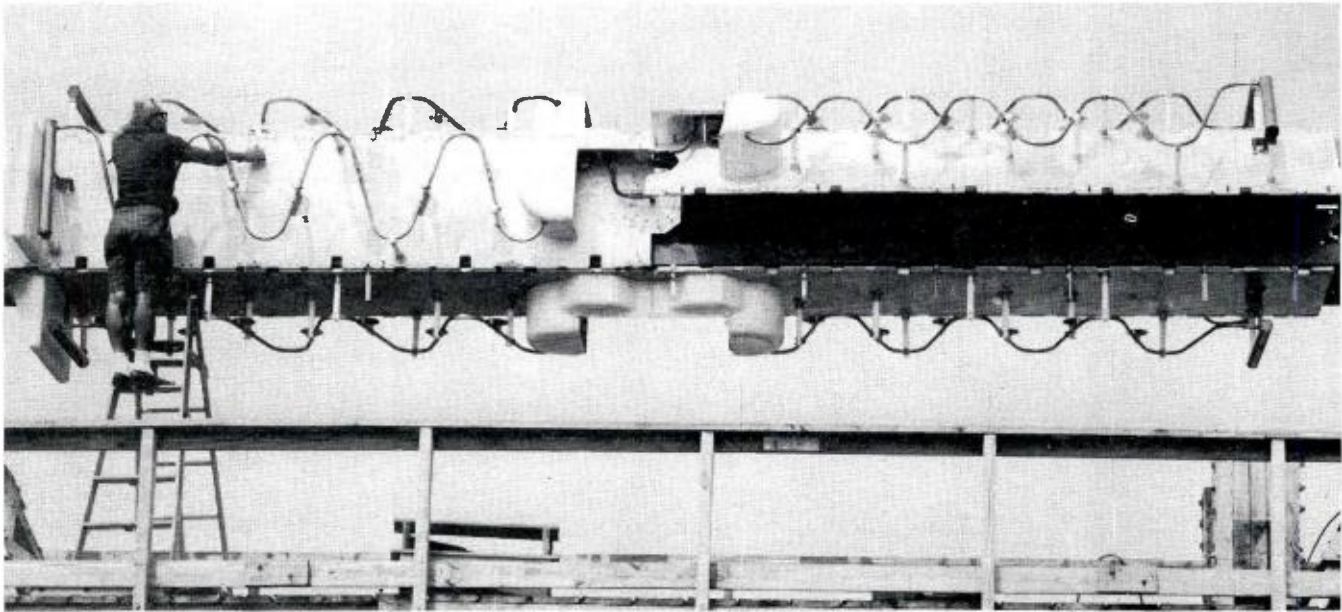

FIG. 5. View of Zee Panel antenna showing one hinged panel partially open which provides access to the feed lines inside. Part of radome cover is also folded back exposing one of the four feed points at the center of the antenna.

Branching from the central feed point and running parallel to the panel surface is the one-inch diameter copper zig-zag element. The element is close spaced to the panel immediately adjacent to the end seal to provide a transforming action to the impedance seen at the input to each half of the array. Near the output of each of these transformers is a disc type impedance trimming capacitor. Distributed at intervals along the element are disc compensating capacitors designed to maintain a traveling wave throughout its length. Toward the top and bottom of the panel the elements flare slightly outward from the panel surface and connect to "end loading" radiators at each end of the panel. These are $3\frac{1}{8}$ -inch copper tubes which also contain electrical de-icers.

Power is distributed equally to each of the four panels from the four-way power divider (Fig. 6) through short $3\frac{1}{8}$ -inch transmission line sections. Each section is equipped with a directional coupler interconnected by flexible cable to the transmitter room for monitoring the reflected signal.

Weather Protection

Enclosing the center portion of each panel where the power density is highest, is a Fiberglas radome (See Fig. 7) which eliminates the need for electrical de-icing of the antenna under normal icing conditions. For the severe icing occasionally experienced at this location, provisions have been made for de-icing the radiators by passing AC current through them. These radomes contribute to stable performance and provide protection from possible damage. They are hinged along one edge and can be uncoupled along the other edge and swung out as shown in Fig. 8 exposing the end seal areas for visual inspection. Fiberglas canopies at the top of the antenna just above the four end-loading radiators as shown in Fig. 8 protect the antenna against damage by ice falling from overhead antennas. There are in addition, Fiberglas pole steps in both the northwest and southeast tower corners.

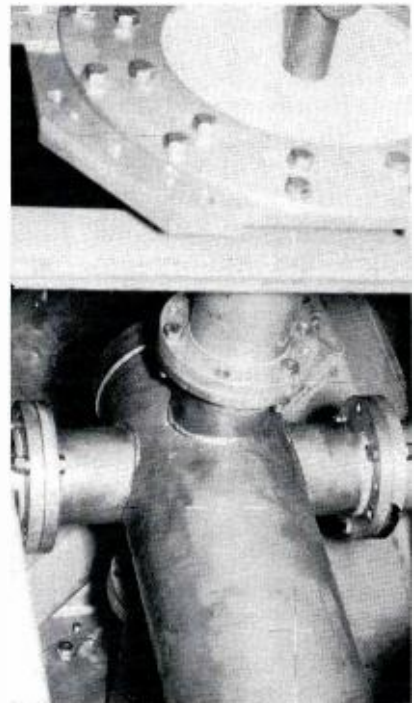

FIG. 6. Closeup view of four-way power divider located just below antenna feed point.

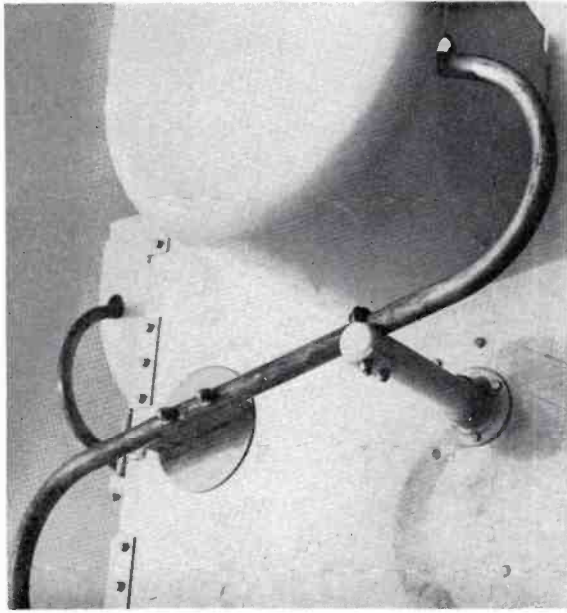

FIG. 7. Photo showing radome protective cover, radiator support and disc-shape impedance compensating capacitor.

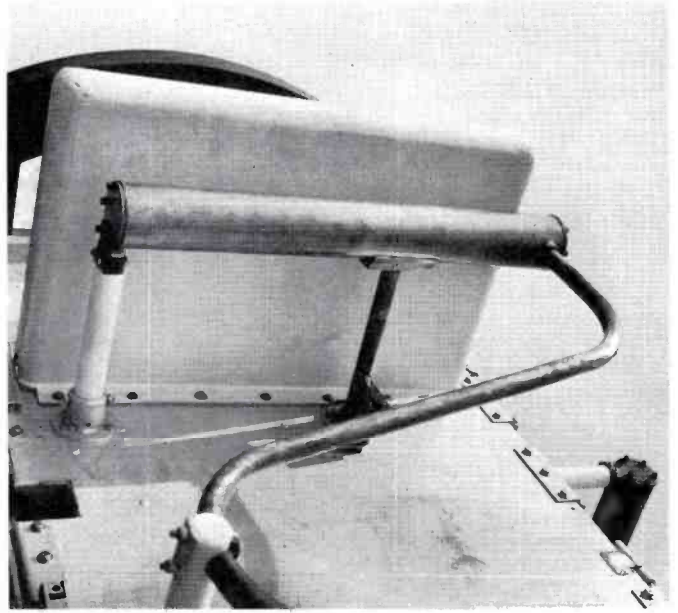
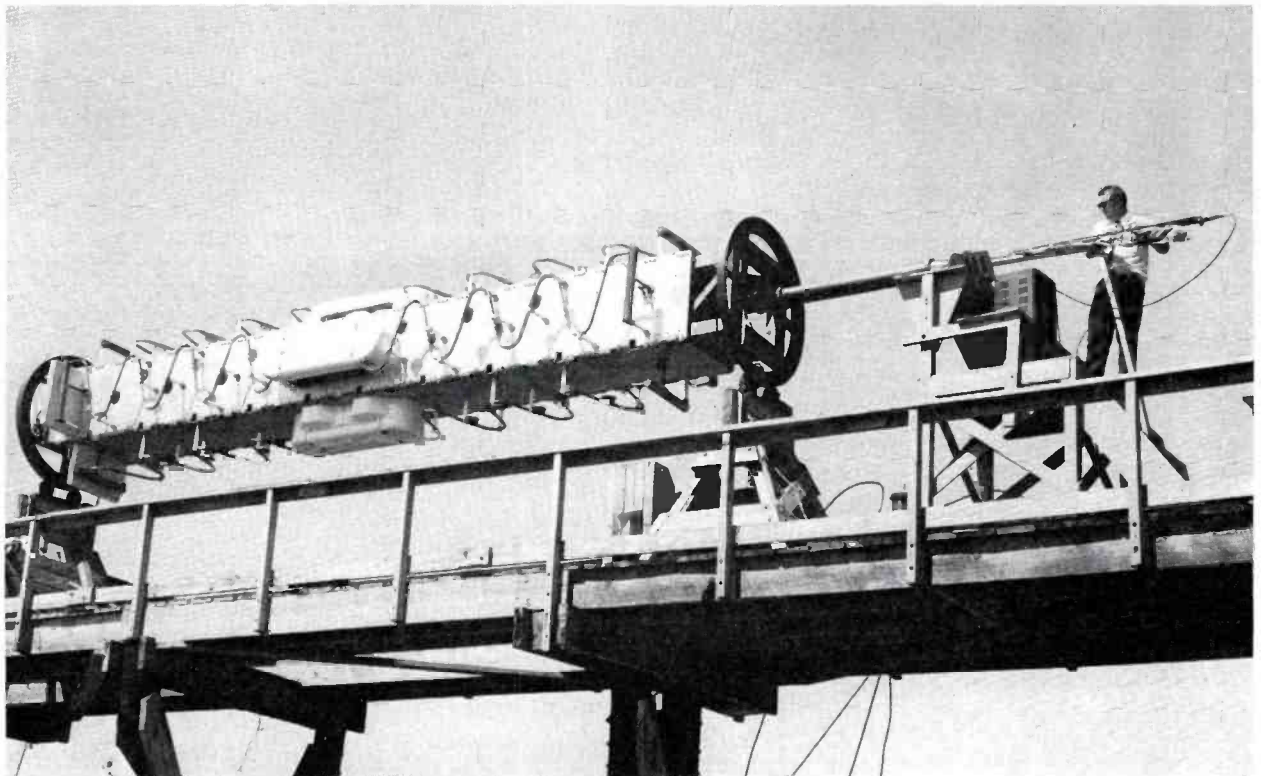

FIG. 8. Fiberglass canopy mounted at top of antenna above radiator protects against ice damage.

FIG. 9. Engineer makes impedance measurements on antenna mounted horizontally on trestle at RCA Gibbsboro test site.



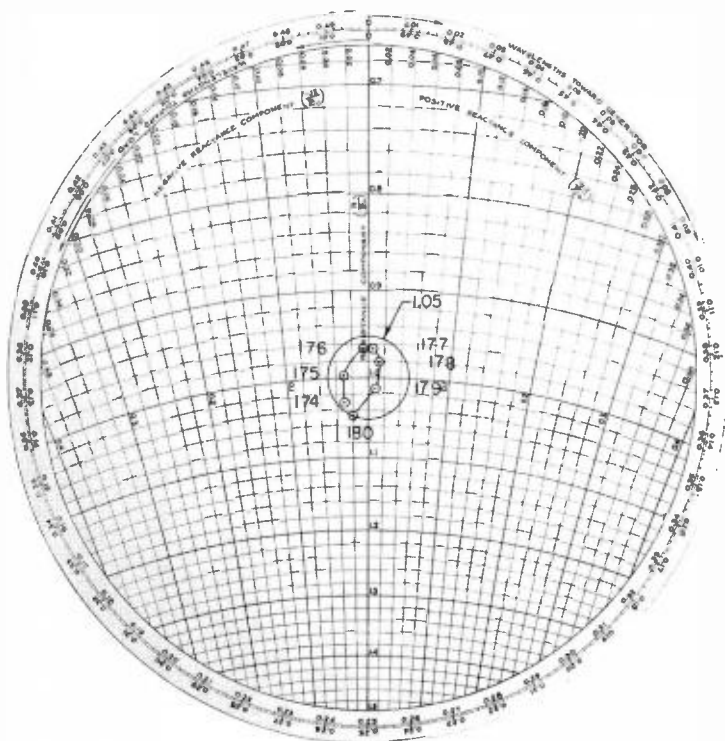

FIG. 10. Smith chart of input impedance for the Zee Panel antenna.

Transmission Line

A completely new 437 foot run of high efficiency, pressurized 6 $\frac{1}{8}$ -inch transmission line (RCA Universal MI-27792) was installed from the manual transfer panel in the transmitter room on the 85th floor to a double 45 degree elbow assembly at the antenna input. A coaxial line section at the manual transfer panel transforms the 51.5 Ohm transmitter room impedance to the main run impedance of 75 Ohms.

Initial Tests

The Zee Panel antenna was completely assembled and mounted on a test tower at the RCA Gibbstown antenna site as seen in Fig. 9 and a demonstration of full compliance with contractual specifications was presented to WABC-TV engineering personnel.

The impedance characteristic of the antenna is shown on the chart, Fig. 10, with the measured VSWR at the 75 Ohm input of 1.05 or better over Channel 7. Measured horizontal and vertical radiation patterns (Figs. 11 and 12) indicate the desired circularity of ± 1.5 dB or better and a completely null filled vertical pattern with a minimum of 10 percent out to 20 degrees below the horizontal, which was also a design requirement. In fact, the broad vertical pattern presented by the antenna made beam tilt unnecessary in the final installation.

Power Gain

The Zee Panel antenna achieved the requirement for an RMS power gain of not less than 3.8 at visual carrier. Actual gain as measured varied from 3.3 to 5.5 (5.19 dB to 7.4 dB) with an RMS gain of 4.2 (6.23 dB).

System Performance

After optimizing the installed antenna system by means of the variable transformer adjacent to the antenna input, system performance was measured by the

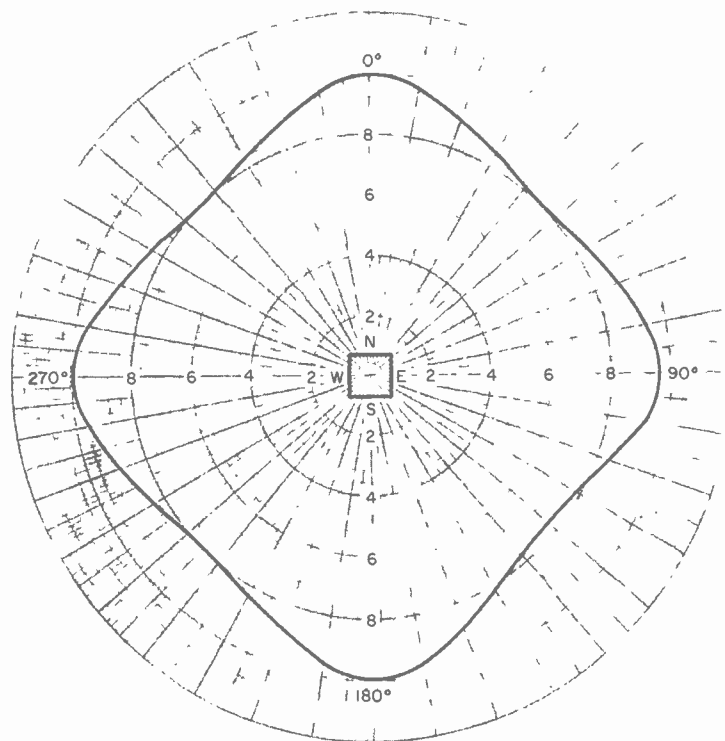

FIG. 11. Horizontal radiation pattern of Zee Panel antenna achieved the desired circularity of ± 1.5 dB or better.

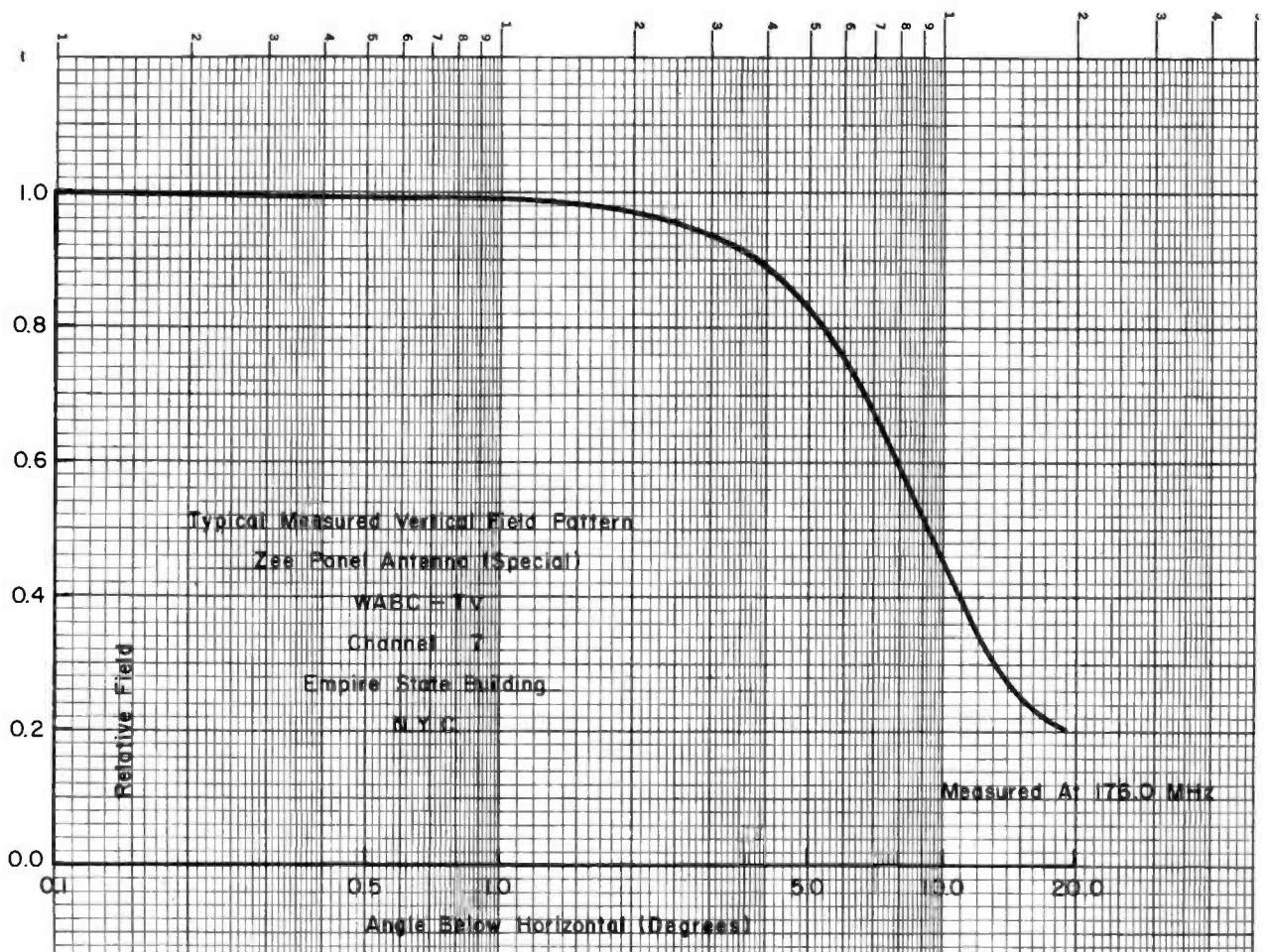

FIG. 12. Vertical radiation pattern of Zee Panel antenna as measured at 176 MHz.

RF pulse technique. The reflected voltage was down 36 dB or 1.6 percent of the incident voltage, well within the contractual requirement of 3 percent. The RF pulse method of adjustment and measurement, as contrasted with the older VSWR criteria, results in a system adjusted for the best possible impedance match between the antenna and transmission line for minimum reflection, i. e. optimum picture quality. The pulse has a fundamental frequency at the operating visual carrier, a pulse width of 0.25 microseconds and a repetition rate of 5,000 per second, simulating the video signal spectrum. The optimum condition is realized when the amplitude of the reflected pulse is minimal.

Performance Monitoring

A remote monitoring feature incorporated into the Zee Panel antenna gives continuous indication in the transmitter room of reflected energy at the feed points of the North, South, East and West radiators. Directional couplers installed on the antenna between the outputs of the four-way power divider and the four feed points and connected to a meter in the transmitter room as previously described, sample reflected voltages which are read and recorded along with the transmitter readings. This permits monitoring the actual operation of the antenna, an extremely valuable convenience from a long term standpoint to indicate stability of opera-

tion, particularly under conditions of sleet, ice and snow.

Conclusion

The Zee Panel antenna represents a design achievement that was especially adapted to WABC-TV's particular antenna problem. Its feed system is simple, resulting in easier installation and minimizing the chances of failure. It meets all the design requirements imposed by the customer. The WABC-TV installation is an example of RCA's experience and capability in antenna engineering, and illustrates one of a variety of antenna designs that RCA can make available to fill special needs.

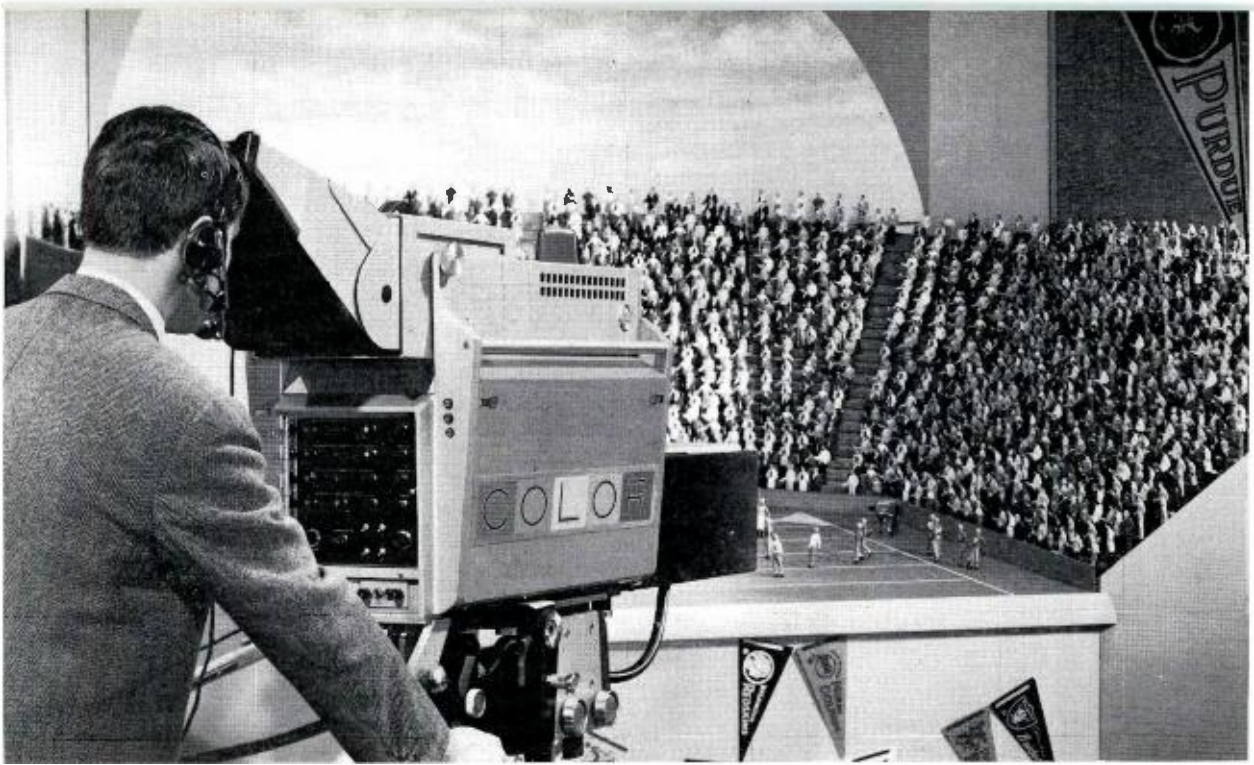

FIG. 1. One of the extraordinary features of the TK-44 is the way it maintains true color fidelity even when panning between the bright sunlit areas and the dark shadows often encountered in field pickups.

NEW "BIG TUBE" COLOR CAMERA FOR FIELD PICKUPS

Simplified Lens System and Unique ISOCON Tube Bring Superior 4-Channel Color to Remote Operations

Broadcasters who liked the general concept of the RCA TK-42/43 Cameras, but wanted a smaller and lighter camera for field use may now have their wish. The RCA TK-44 Color Camera, shown for the first time at the NAB, is especially designed for remote pickup service. Not only is it smaller and lighter but for additional ease in carrying, the viewfinder and zoom lenses may be detached. The camera proper weighs just 140 pounds. Another feature, especially desirable for field use, is the location of major setup and operating controls at the video operator's position. These, and other features noted below, make the TK-44 the ideal color camera for remote pickups. While the TK-42 (with internal zoom) and the TK-43 (with external zoom) will probably remain the standard cameras for studio use, the TK-44 is a notable addition to the RCA line and one

which will make it possible for stations to use the same type of camera in the field as they use in the studios.

In this article the general features of the TK-44 Camera are briefly noted. In a forthcoming issue a more detailed description will be presented.

Separate Luminance Channel

The TK-44 follows the RCA concept of providing a separate, high quality luminance channel, as used in the TK-42 studio and TK-27 film cameras. The separate luminance channel produces a high definition monochrome signal that adds picture detail and sharpness to the color image.

New ISOCON Luminance Tube

The luminance pickup tube in the TK-44 is a new type of three inch image orthicon known as an ISOCON. This recently devel-

oped tube exhibits exceptionally high signal to noise ratio while still retaining "knee" operation, excellent gray scale and all the other desirable characteristics of a conventional I. O. The knee characteristic assures a degree of automatic gain control while producing good picture detail in the highlights. The new ISOCON achieves picture sharpness and contrast range beyond that attainable with photoconductive tubes.

Simplified Lens System

The new and efficient optical path of the TK-44 is the work of the best optical designers in the world. The simplified system eliminates the field lens and relay lens from the luminance channel for maximum picture sharpness and absence of vignetting. Zoom lenses, either manually or servo controlled such as Varotal and Angenieux lenses can be ordered especially for use on

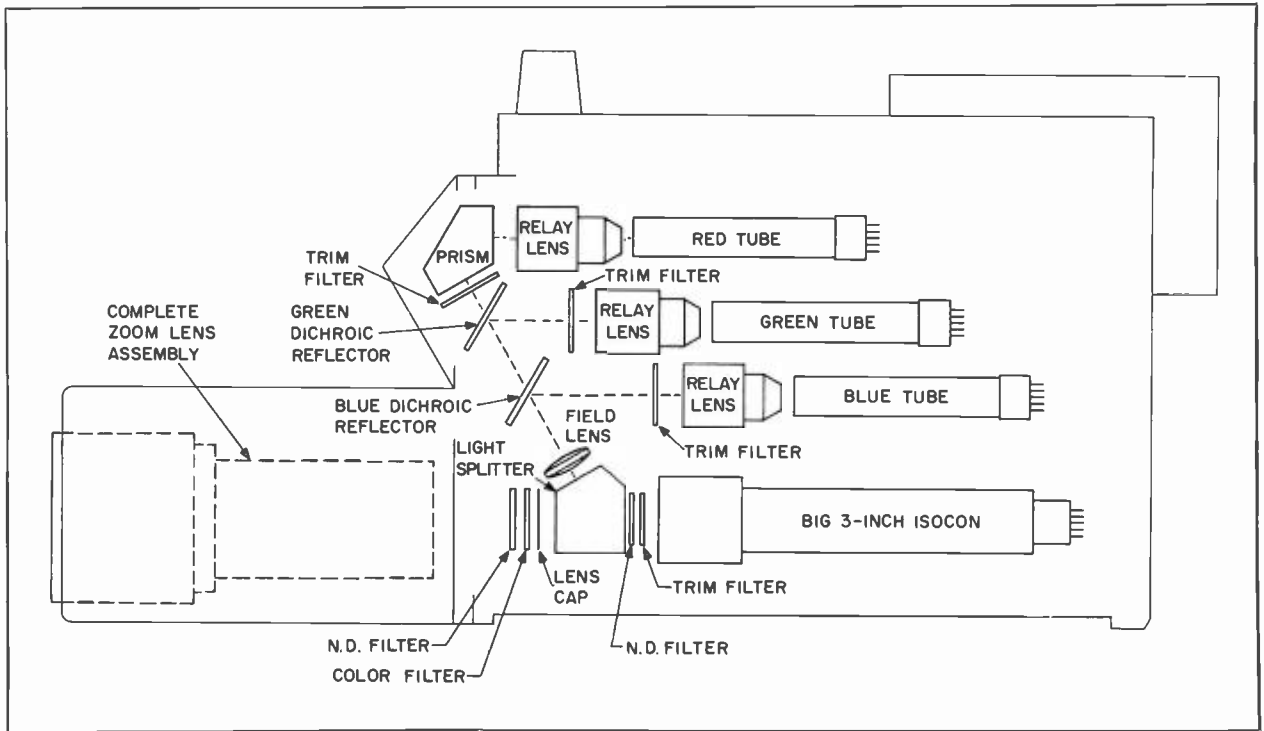

FIG. 2. Diagram showing arrangement of lens system for ISOCON big luminance tube and three chroma pickup tubes.

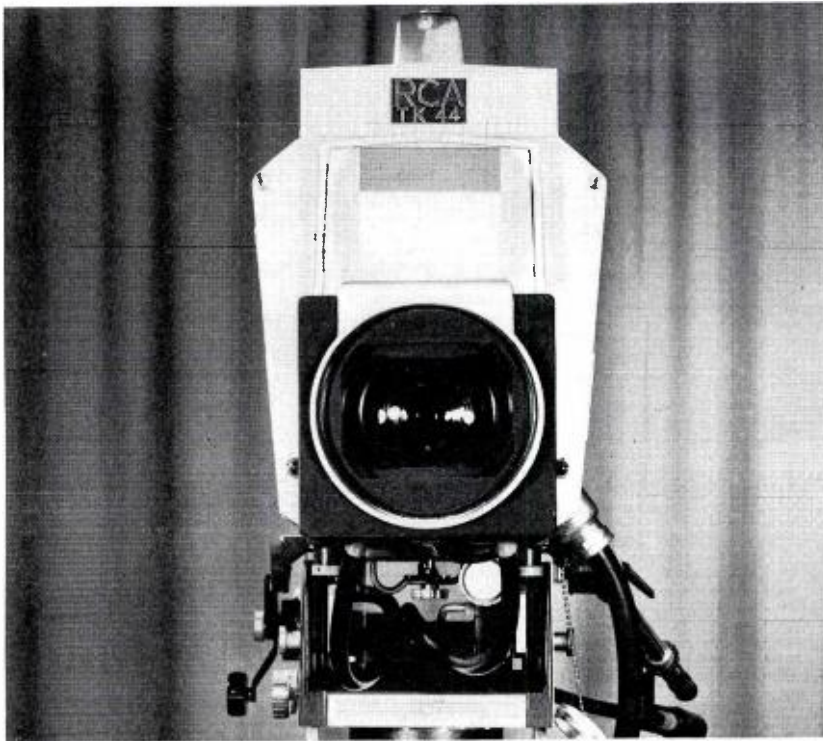

FIG. 3. Small physical size of camera, particularly the slender width, allows operator virtually unrestricted view of scene.

the TK-44. Another feature of the camera is the built-in externally operated neutral density filter wheel which handles a large range of outdoor lighting conditions. The filter holder provides a desired depth of field under various lighting situations.

Operating Flexibility and Ease

Major setup and operating controls are provided at the video operator's position for maximum flexibility in the field. Remoted controls include: iris, black level, white level, black balance, white balance and chroma level, plus targets, beams, electrical focus, alignment, registration, shading and gamma. There is four channel control of important functions such as variable gamma, shading, and black level and white level.

Carefully designed gamma circuits allow close match of all pick up tubes. The camera lens can be capped either at the camera or from the control position without disturbing the setting of the built-in neutral density filter.

Another operator-oriented feature of the camera is the narrow width of only 15 inches, achieved by special mounting of the four pickup tubes. Yet the camera is not high, and it is considerably shorter than other color cameras. The

cable enters the side of the camera, near the center of gravity, at a 45 degree angle—out of the operator's way.

Simplified Camera Interconnections

Horizontal and vertical pulses are derived from sync thus eliminating the need for distribution of the horizontal and vertical drive signals previously required for camera equipment. This saves two coax runs and two distribution amplifiers, and is an extremely important convenience feature for outdoor broadcasts. The only input signals required for the camera chain are sync, blanking, color subcarrier and burst flag.

In addition, self adjusting circuits automatically compensate for time delays as well as voltage changes due to different cable lengths. Full compensation is provided for up to 2,000 feet of camera cable. No additional power supplies are needed for this length of cable.

Other Built-In Extras

Also built into the camera equipment is an encoder and a color bar test signal generator that provides standard full raster color bar test signals of 0.7 and 1.0 Volt levels for adjustment of encoder circuitry.

Built-in signal-level test circuits combined with the automatic features provide a more reliable setup and test procedure.

All Solid State

Except for the camera tubes and viewfinder kinescope, the TK-44 is completely solid state, assuring long equipment life and minimum maintenance. Circuits of the camera and auxiliary equipment are modularly packaged for compactness, easy access and quick interchange. High performance can be expected over long periods of time due to the use of circuit stabilizing techniques and precise control of voltages and currents.

Conclusion

The TK-44 ideally fulfills the requirements for a lightweight color camera, particularly designed for remote pickup service. The detachable viewfinder and detachable zoom lens separate the camera chain into three easily transported pieces, the heaviest of which is the camera head itself at only 140 pounds. Contributing significantly to a new high signal-to-noise ratio in color pictures is the newly developed ISOCON in the separate luminance channel. The TK-44 is certain to bring to field operations a measure of the superb color performance that the companion TK-42 color camera is introducing to studio operations across the country.

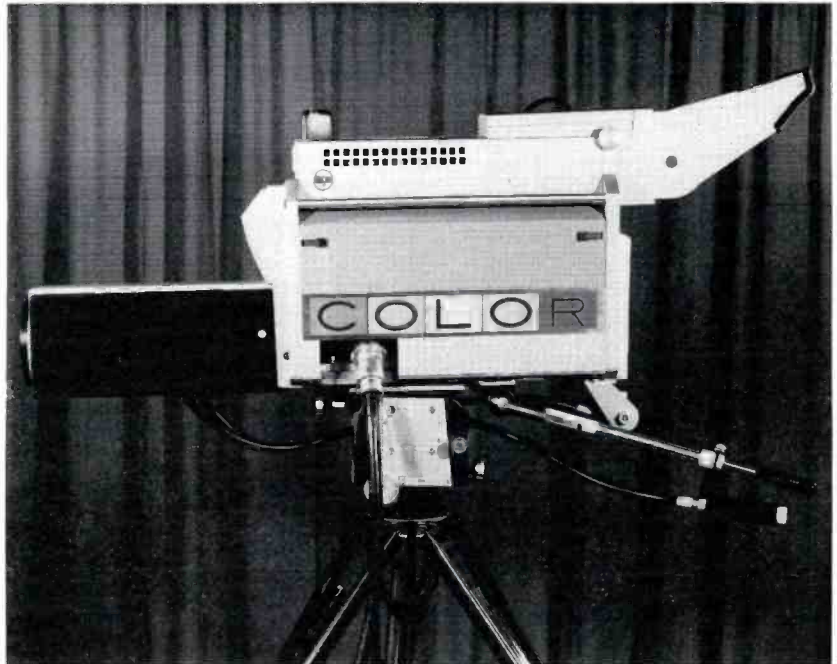
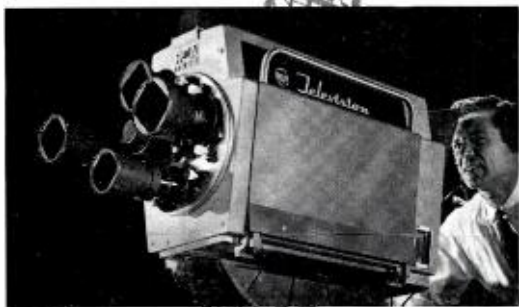

FIG. 4. Designed for convenience and ease of handling, video cable enters camera near center of gravity, offering minimum drag and out of operator's way. Panning handle with zoom control can be attached to either side of camera.

FIG. 5. Focus controls are grouped for easy operation by one hand. Viewfinder and zoom lens assembly are detachable from camera head for easy portability.





Command Performance?

RCA SERVICE DELIVERS

Expert Repair and Overhaul Service

- FOR:
- Video tape recorders
 - TV Cameras
 - Antennas
 - Microphones
 - Transmitters
 - Installation
 - Console
 - TV Projectors
 - Microwave

For full information about fast dependable broadcast equipment maintenance service from RCA, call either of these offices:

Chicago (312) WE 9-6117
Philadelphia (215) HO 7-3300

Or write:
RCA SERVICE COMPANY
A Division of Radio Corporation of America
Technical Products Service
Industrial Center, Camden, N. J. 08101



The Most Trusted Name in Electronics

"BIG TUBE" COLOR FILM SYSTEM

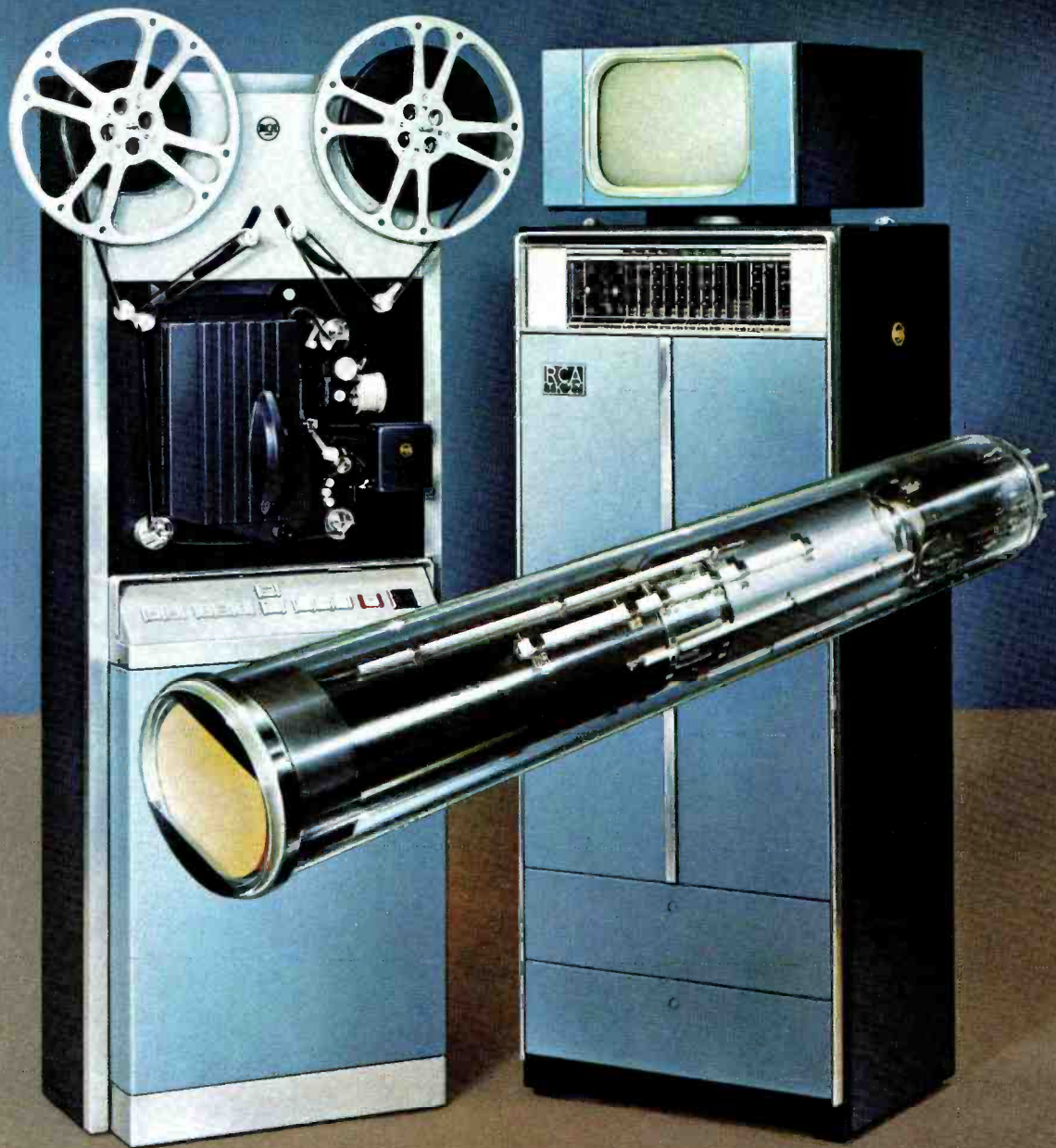

FOR COLOR FILMS...TK-27—BIG tube film system...makes the big difference in your color film pictures...maintains color quality, automatically compensates for film and slide variations. A "matched" equipment from RCA.



The Most Trusted Name in Electronics

